

COLLEZIONE NOTTE

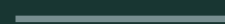

Vega Night Collection

SPAGNOLmobili

www.spagnol.it

VEGA NIGHT__

VEGA NIGHT__

Vega Night è il sistema di armadiature a spalla firmato Spagnol Mobili, pensato e progettato nel segno della qualità e del design made in Italy.

Estetica e funzionalità si uniscono in progetti contenitivi tutti componibili, che raccontano di idee innovative tradotte in soluzioni versatili.

Da oltre cinquant'anni abbracciamo la casa a 360 gradi, fornendo un servizio completo che racconta della nostra passione per l'arredamento.

Vega Night is the “shoulder-system” signed by Spagnol Mobili, thought and realized with the quality and the design made in Italy.

Aesthetic and functionality join together in holding projects, all modular, which tell about innovative ideas translated in flexible solutions. From over 50 years we hug the home in 360° making a complete service which tell our passion for furniture.

VEGA NIGHT __

Progetti d'arredo su misura

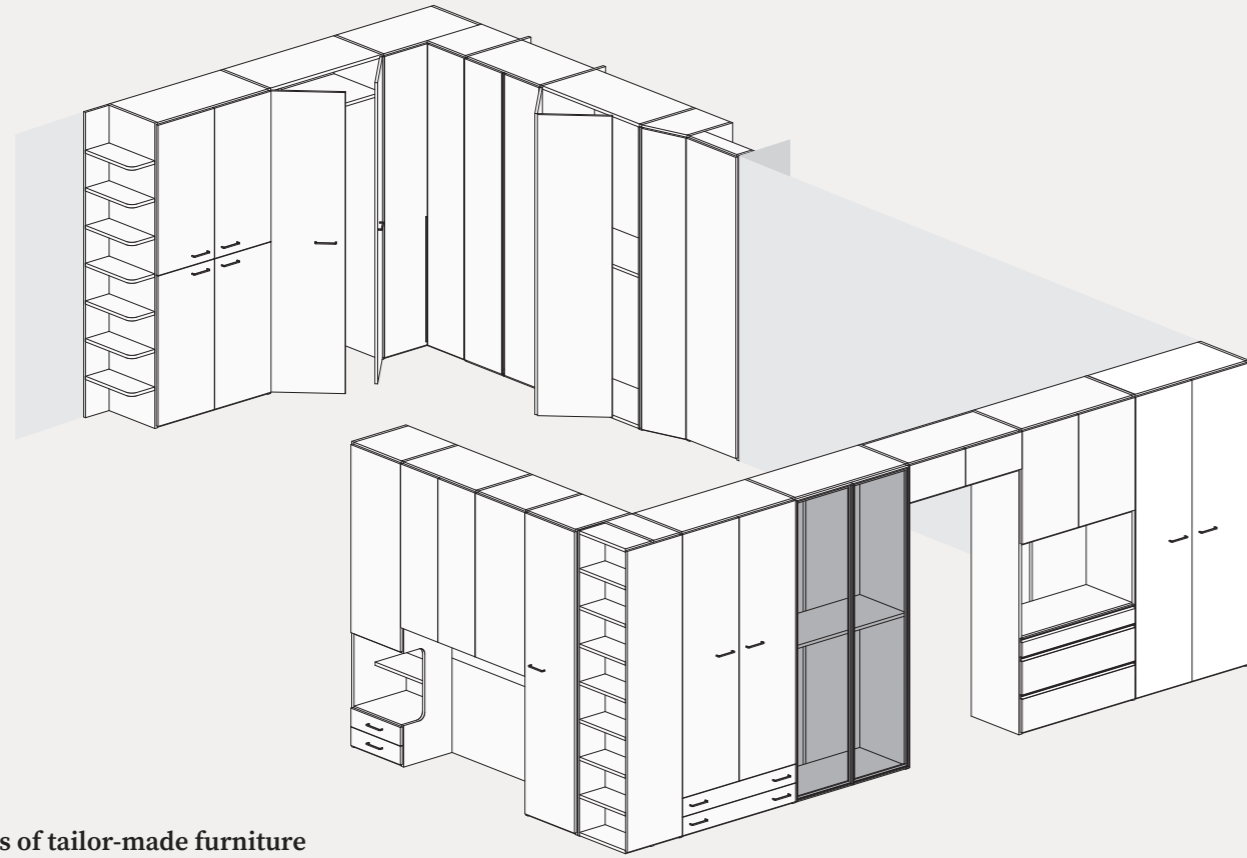

Projects of tailor-made furniture

Tante possibilità compositive per rendere l'armadio molto più di un semplice arredo.

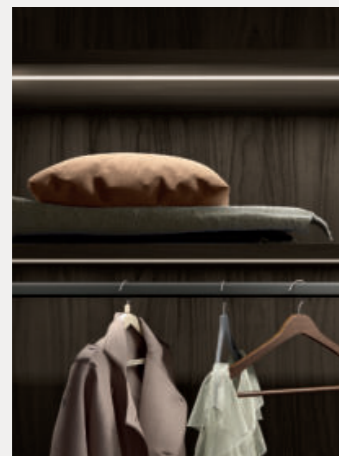

Lots of componible possibilties in order to make the wardrobe much more then a simple furniture.



Indice / Index

Progetti per ogni esigenza abitativa: qualunque sia lo spazio disponibile, Spagnol Mobili offre le soluzioni più adeguate ed innovative.

Projects for every home needs: no matter how is the available space, Spagnol Mobili offers innovative and appropriate solutions.



007__comp. page 64



008__comp. page 72



009__comp. page 80



010__comp. page 88

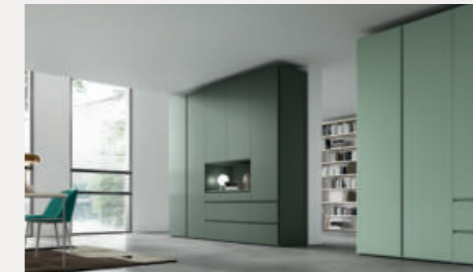

011__comp. page 96



012__comp. page 104



001__comp. page 10



002__comp. page 20



003__comp. page 28



013__comp. page 110



014__comp. page 116



015__comp. page 128



004__comp. page 34



005__comp. page 42



006__comp. page 52



016__comp. page 134



VEGA NIGHT__

La cura per lo spazio e per il dettaglio
The treatment for the space and for the detail

001 _ comp.

Chiari e scuri in armonia
Light and dark in harmony



L'elegante boiserie Fusion è completata da una luce a led integrata sui ripiani a vista: nell'armadio Vega Night tutto è a portata di mano, per una maggiore funzionalità.

The elegant Fusion Boiserie is completed by a led-light integrated on the shelves: in the Vega Night wardrobe is all comfortable for a major functionality.





La nicchia ricavata nell'armadio arricchita da una luce a led, crea un ambiente moderno e funzionale.

The niche cut into the wardrobe by a led-light creates a functional and modern environment.

Night Collection

La colonna ad angolo permette di arredare, sfruttando al massimo, anche gli spazi più difficili. L'interno viene illuminato con dei sottili ed eleganti profili led incassati nei fianchi.

The corner column permits to furnish each space, also the one more difficult. The inner side is illuminated with some elegants and thin led lights integrated into the sides.



001 _ comp.

Armadio angolare composto da colonne e ponte Vega Night con ante Axel, vano sottoponte con basi Vega Day P. 600 mm con ante Axel e pratica boiserie Fusion attrezzata con ripiani.

Corner wardrobe realized with Vega Night columns and bridge with "Axel" doors, element below with Vega Day bases D. 600 mm with Axel doors and practical Fusion Boiserie with shelves.

Armadio Vega Night _

Wardrobe

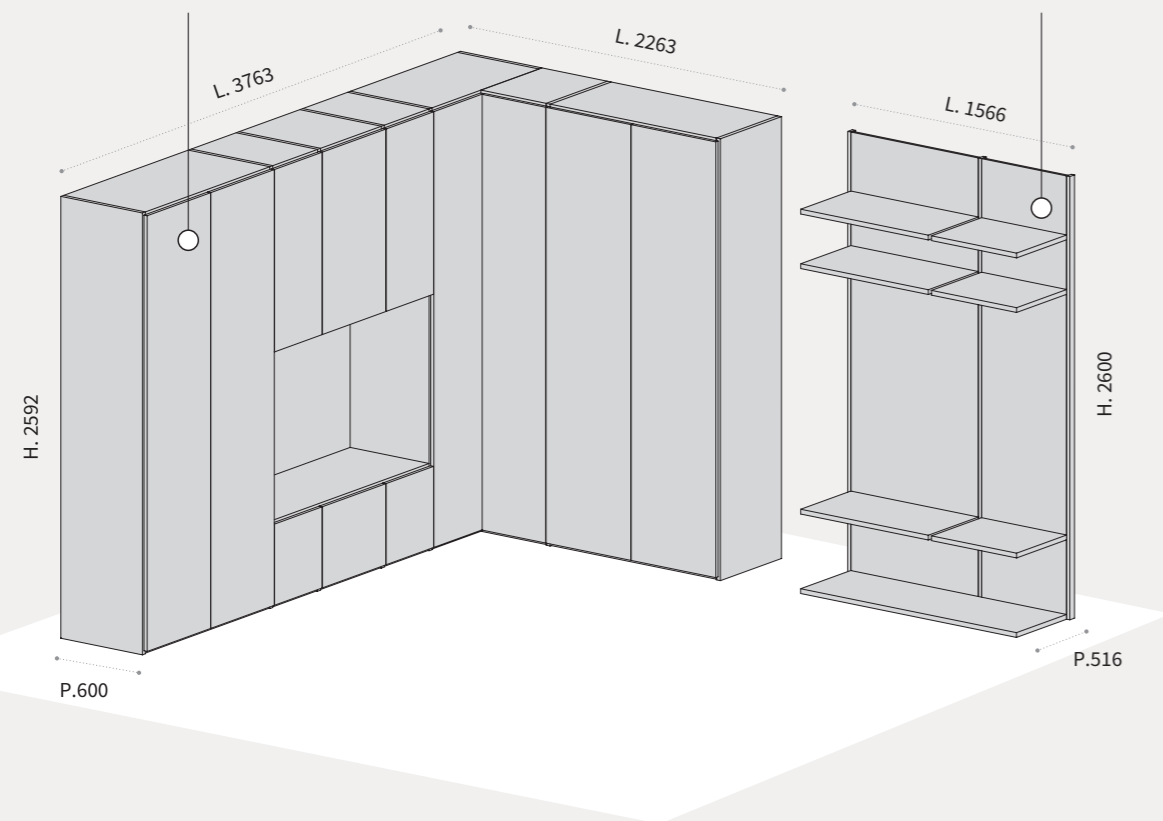

Boiserie Fusion _

Boiserie Fusion

Night Collection

Armadio _

Wardrobe

Armadio Vega Night
con frontali Axel
L. 3763 x 2263 P.600 H.2592 mm
Struttura: Grigio Londra
Schienale ponte: Noce Cotto
Frontali: Grigio Londra
Maniglia: Incasso Grigio Londra
Tessuto: Cat.E n.53
Illuminazione: Strip led
nel vano sottoponte
Led incassato nei fianchi
della colonna

Vega Night wardrobe
with "Axel" frontals
L. 3763 x 2263 D. 600 x H. 2592 mm
Structure: Grigio Londra
Bridge back: Noce Cotto
Frontals: Grigio Londra
Handle: Incasso Grigio Londra
Fabric: Cat. E nr. 53
Illumination:
led-light integrated
on the column sides

Boiserie _

Boiserie Fusion
L. 1566 x P.516 x H.2600 mm
Schienali: Noce Cotto
Mensole e pedana: Noce Cotto
Illuminazione: led incassato
su ripiano

Boiserie Fusion
L. 1566 x D. 516 x H. 2600 mm
Back: Noce Cotto
Shelves and platform: Noce Cotto
Illumination: led-light integrated
on the shelf

Finiture
Finishes



Grigio Londra

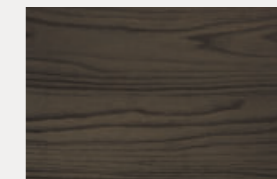

Noce Cotto

Tessuto
Fabric

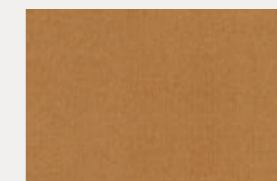

Cat. E n. 53

002 _ comp.

Soluzione con armadio a ponte

Solution with bridge-wardrobe



Lo scrittoio sospeso Jump trova spazio nel vano sottoponte dell'armadio Vega Night.

The suspended plan Jump finds space on the Vega element under the bridge.



Night Collection

L'appendiabiti è open con il sistema a tubi modulari
Pipe: un plus di stile dove il contenimento si fa
spazio, in tutta la sua originalità.

The coat-hanger is open with the modular pipe
system Pipe: a fantastic style where the holding
makes space with all its originality.



002 _ comp.

Armadio composto da colonne Vega Night con anta Unica, ponte Vega Night con anta Axel e colonna a giorno Vega Day. Nel vano sottoponte trova spazio lo scrittoio sospeso Jump.

Wardrobe composed by Vega Night columns with Unica door, Vega Night bridge with Axel door and open column Vega Day. On the element under the bridge finds space the suspended plan Jump.

Armadio Vega Night _

Wardrobe

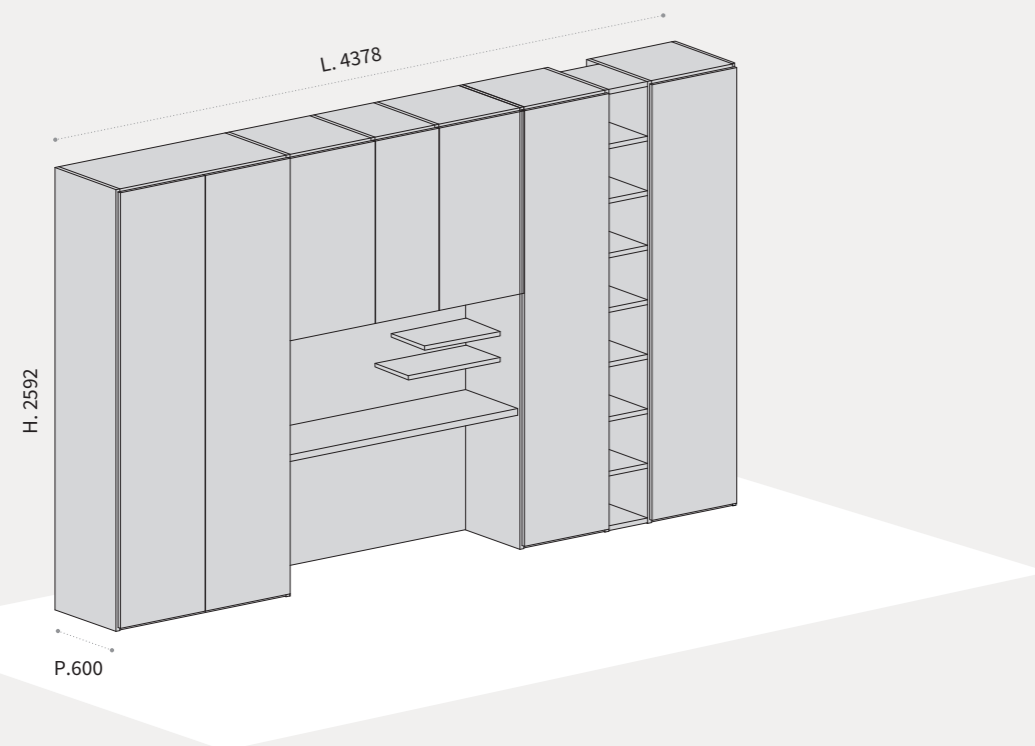

Night Collection

Armadio _

Wardrobe

Armadio Vega Night
con frontali Unica e Axel
L.4378 x P.600 x H.2592 mm
Struttura: Platino e Fango
Schienale ponte: Fango
Frontali: Platino e Fango
Profili anta: Platino
Illuminazione: strip led
nel vano sottoponte

Vega Night Wardrobe with
Unica and Axel frontals
L.4378 x D.600 x H.2592 mm
Structure: Platino and Fango
Back bridge: Fango
Frontals: Platino and Fango
Door profiles: Platino
Illumination: led-light on the
element under the bridge

Finiture
Finishes

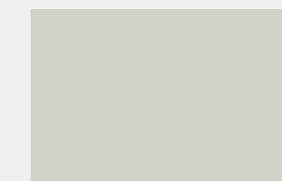

Platino

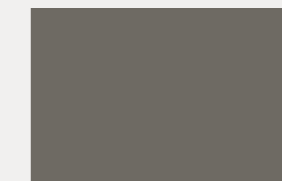

Fango

Tessuto
Fabric



Cat. F n. 22

003 _ comp.

Funzionalità contenitiva

Holding Functionality





Night Collection

Taglio inclinato sulle ante oppure in altezza:
anche le esigenze di spazio particolari, come gli
ambienti a mansarda, trovano soluzione.

Inclined cut on the doors or in height:
also the particular space needs, like the attic
environment, find solution.

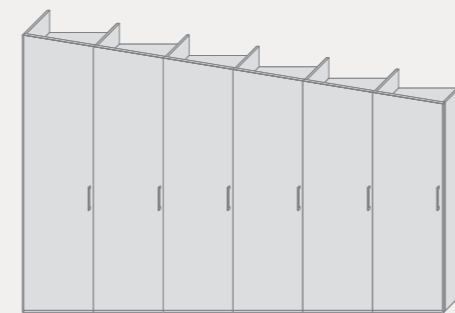

**Armadio battente con taglio
inclinato sulle ante**
Hinged wardrobe with inclined
cut on the doors



**Armadio battente con
taglio obliquo in altezza**
Hinged wardrobe with
inclined cut in height

003 _ comp.

Armadio “sottotetto” composto da colonne Vega Night attrezzate con ante e cassettoni Axel. Le ante superiori vengono realizzate con taglio in obliquo, così che l’armadio si adatti agli ambienti particolari come quelli mansardati.

“Under-roof” wardrobe composed by Vega Night column with Axel doors and drawers. The superior doors are realized with inclined cut so that the wardrobe can be adapted to particular space like in the attic.

Armadio Vega Night _

Wardrobe

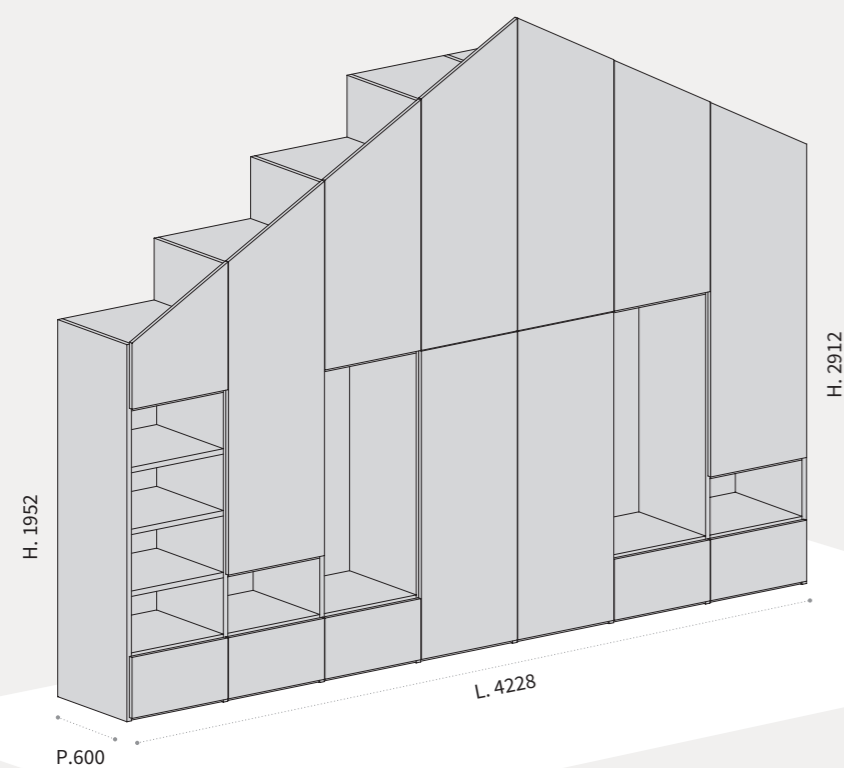

Night Collection

Armadio _

Wardrobe

Armadio Vega Night
con frontali Axel
L. 4228 x P.600 x H.1952/2912 mm
Struttura: Madreperla
Schienale: Noce Cotto
Frontali: Beton Madreperla
Maniglia: Push-pull
Illuminazione:
led incassato su ripiano

Vega Night Wardrobe
with Axel frontals
L.4228 x D.600 x H.1952/2592 mm
Structure: Madreperla
Back: Noce Cotto
Frontals: Beton Madreperla
Handle: push-pull
Illumination:
led-light on the shelf

Finiture
Finishes

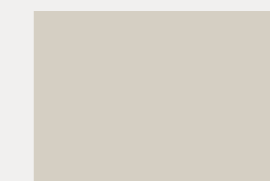

Madreperla



Giada

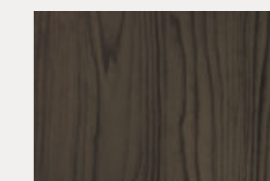

Noce Cotto



Beton Madreperla

004 _ comp.

L'armadio completa lo spazio

Wardrobe completes the space



La boiserie Fusion è arricchita da pratici dettagli, come l'elemento con due vassoi estraibili e le mensole con illuminazione integrata.

Fusion boiserie is enriched by practical details like the element with two removable trays and the shelves with integrated light.





Comodità, design e funzionalità: ogni oggetto trova il suo posto, raccontando dello stile e della personalità di chi lo vive.

Comfort, design and functionality: each object find its place telling about style and personality of those who live it.



004 _ comp.

Armadio angolare realizzato con colonne Vega Night con ante Axel e terminale con ripiani stondati. Sulla parte destra la boiserie Fusion dotata di ripiani, pedana con cassettera in appoggio e vassoi estraibili.

Corner wardrobe realized with Vega Night coloumn with Axel doors and with shaped shelves on the terminal element. On the right side the Fusion boiserie with shelves, platform with drawer and removable trays.

Armadio Vega Night _

Wardrobe

Boiserie Fusion _

Boiserie Fusion

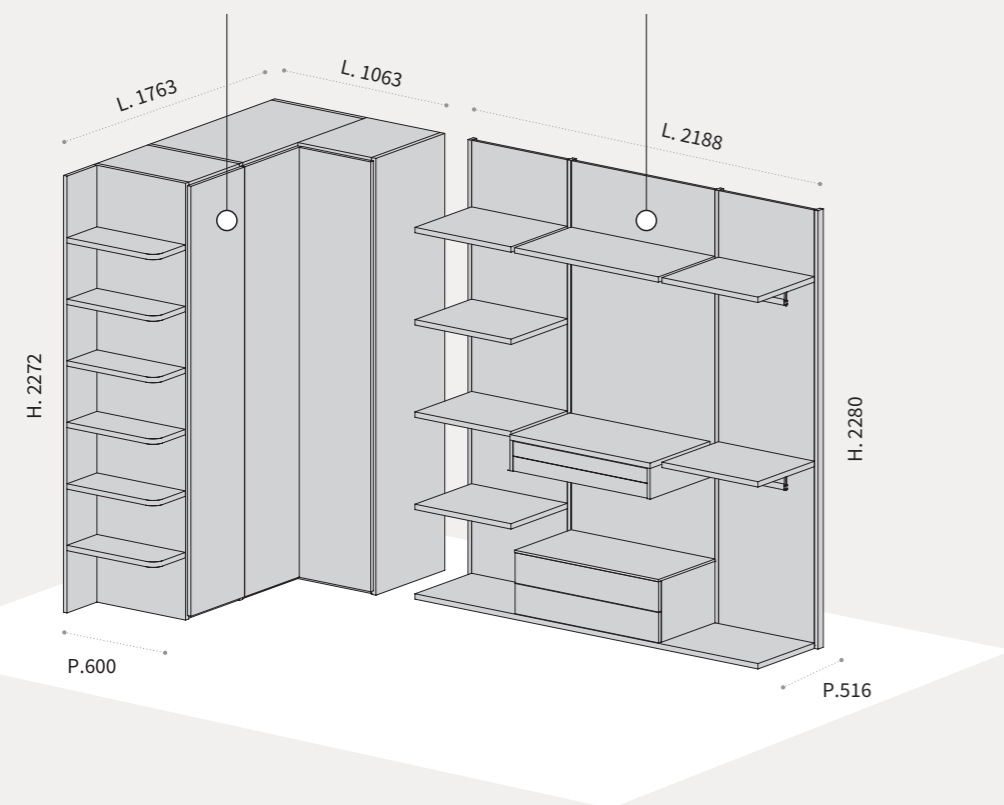
**Night Collection****Armadio** _

Wardrobe

Armadio Vega Night
con frontali Axel
L. 1763/1063 x P. 600 x H. 2272 mm
Struttura: Sabbia
Frontali: Sabbia
Maniglia: Filo 320 Metal Grey

Vega Night wardrobe
with Axel frontals
L. 1763/1063 x D. 600 x H. 2272 mm
Strcture: Sabbia
Frontals: Sabbia
Handle: Filo 320 Metal Grey

Boiserie _

Boiserie Fusion
L. 2188 x P. 516 x H. 2280 mm
Schienali: Noce Canaletto
Mensole e pedana: Sabbia
Elemento con vassoio: Sabbia
Illuminazione: led incassato
sul ripiano
Maniglia: Filo 160 Metal Grey

Fusion Boiserie
L. 2188 x D. 516 x H. 2280 mm
Back: Noce Canaletto
Shelves and platform: Sabbia
Element with tray: Sabbia
Illumination: led-light integrated
on the shelf
Handle: Filo 160 Metal Grey

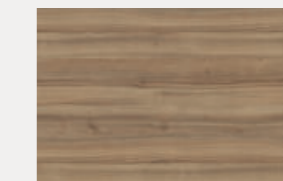
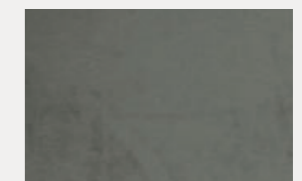
Finiture
Finishes**Sabbia****Noce Canaletto****Tessuto**
Fabric**Cat. F n. 142****B325**



005 _comp.

Una camera aperta allo stile
An open bedroom to the style



Confortevole e capiente,
il nuovo letto è perfetto per un
riposo rilassante, con un tocco
di raffinata eleganza.

Comfortable and large, the new
bed is perfect to have a relaxing
rest, with such a refined elegance.

Boiserie ARCHIMEDE

La boiserie Archimede combina una mensola ad uso scrittoio a mensole porta oggetti ed elemento con cassettone, per uno spazio home office dove non manca nulla.

Archimede boiserie combines one shelf used as a desk to shelves where to put objects and drawer element for an "home office" space where nothing is missing.

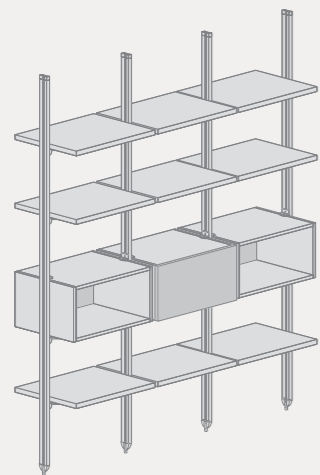

Esempio composizione bifacciale con montanti a soffitto
Example of double-sided composition with montants up to the ceiling

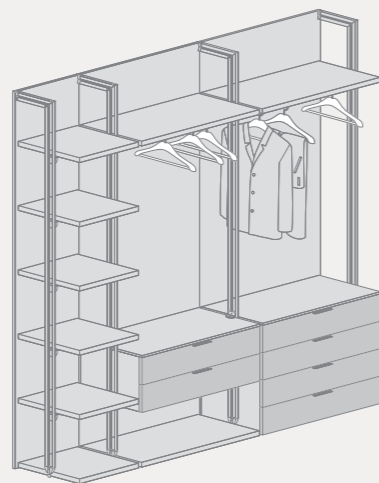

Esempio composizione con montanti a parete e pannelli di rivestimento muro
Example of composition with montants and covered panels to the wall



Night Collection

I cassettoni con maniglia Omega uniscono il design alla praticità, per un'estetica della casa che è anche funzionale.

Drawers with Omega handle join the design to the practicality for an home aesthetic which is also functional.



005 _ comp.

Armadio Vega Night con ante e cassettoni Omega completo di colonna terminale a ripiani e anta.
Sulla parte destra, capienti basi Vega Day P. 60 cm attrezzate con cassettoni Omega.

Vega Night wardrobe with Omega doors and drawers completed with a terminal element with shelves and doors.
 On the right side Vega day bases d. 60 cm with Omega drawers.

Armadio Vega Night _

Wardrobe

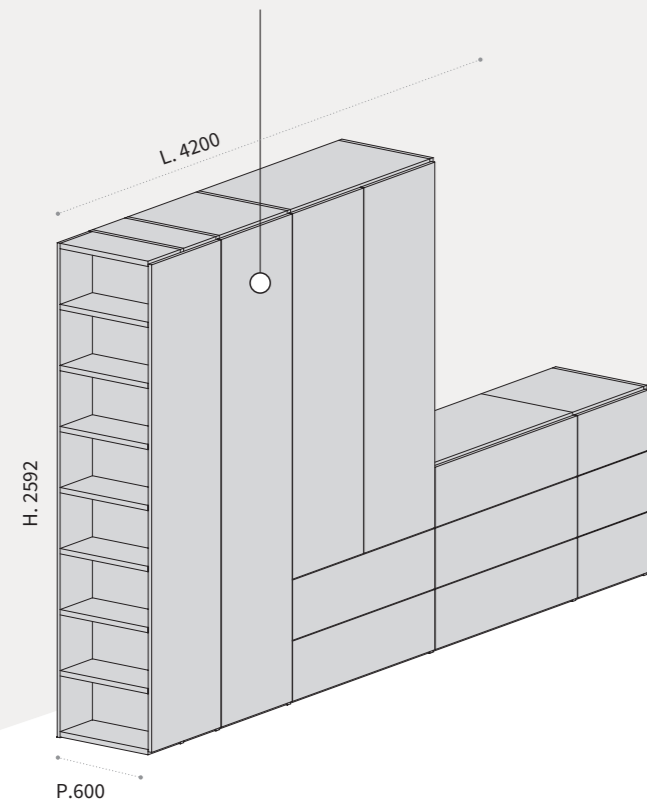

Boiserie Archimede _

Boiserie Archimede

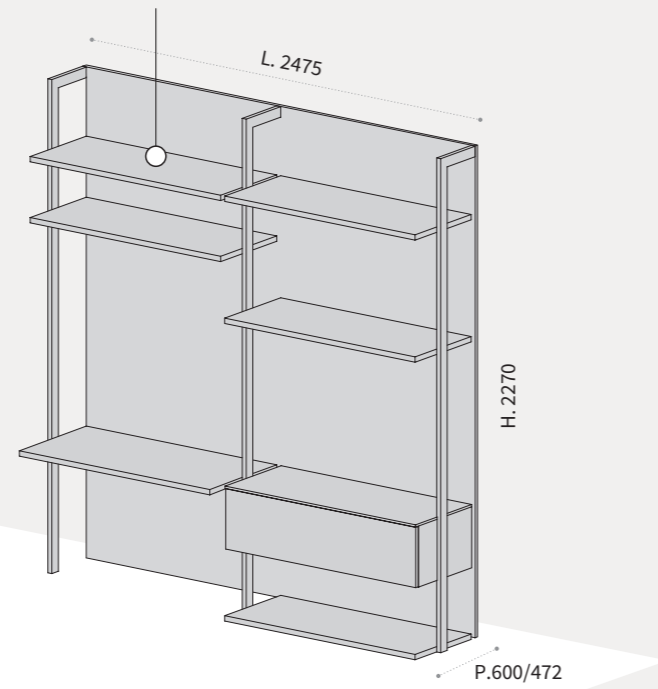

Night Collection

Armadio _

Wardrobe

Armadio Vega Night
 con frontali Omega
 L. 4200 x P. 600 x H. 992/2592 mm
 Struttura: Grigio Londra
 e Verde Militare
 Frontali: Grigio Londra
 e Verde Militare
 Profili maniglia: Verde Militare

Vega Night wardrobe
 with Omega frontals
 L. 4200 x P. 600 x H. 992/2592 mm
 Strcuture: Grigio Londra
 and Verde Militare
 Frontals: Grigio Londra
 and Verde Militare
 Handle profiles: Verde Militare

Boiserie _

Boiserie Archimede
 L. 2475 x P. 600/472 x H. 2270 mm
 Schienali: Serigrafia Movie
 Mensole e pedana:
 Verde Militare
 Elemento con cassettone:
 Verde Militare

Archimede Boiserie
 L. 2475 x D. 600 x H. 2370 mm
 Back: Serigrafia Movie
 Shelves and platform:
 Verde Militare
 Element with drawer:
 Verde militare

Finiture
 Finishes

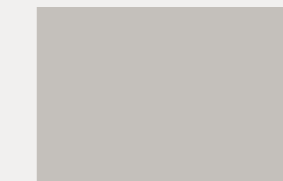

Grigio Londra



Verde Militare



Serigrafia Movie

Tessuto
 Fabric



Cat. E 56

006 _ comp.

Leggerezza d'insieme e versatilità
Lightness overall and versatility



Boiserie FUSION

La boiserie Fusion viene attrezzata con elementi come mensole o cassettiere sospese, per caratterizzare lo spazio con un'impronta personale.

Fusion boiserie equipped with elements like shelves or suspended drawers to characterize the space with a personal sign.

Esempio composizione
Composition example

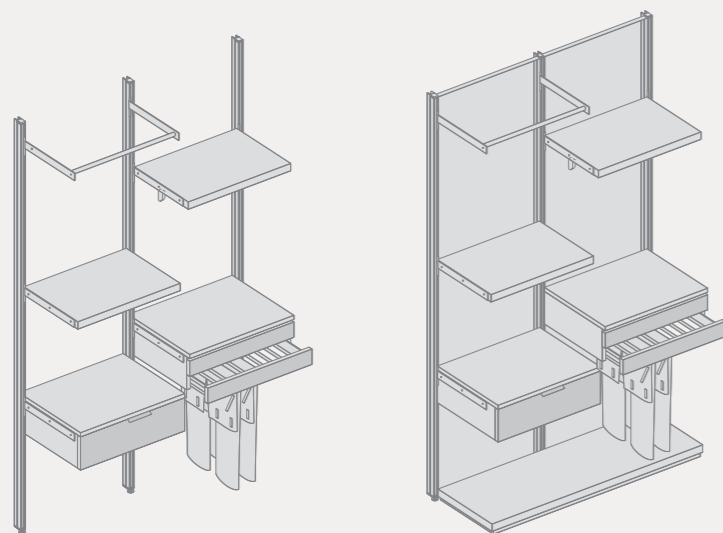

Con muro a vista
On the wall

Con pannello schienale
With back panel



Pratico comodino o piano d'appoggio sospeso, per una chiave interpretativa diversa: il pensile Teka, combinato alla Boiserie Max e testata Pentagramma, compone una melodia tutta nuova nella zona notte.

Practical night-table or suspended desk for a different interpretative key: Teka hanging together with Max boiserie and Pentagramma head creates a new melody in the night zone.



Le ante in vetro rivelano
l'ordine interno, scandito
da appendiabiti e ripiani
portaoggetti che contengono
racconti di vita quotidiana.

The glass-doors reveal the inner order, with
coat-hanges and shelves where to put objects
that contain stories of the daily life.



Due possibilità compositive per personalizzare l'armadio: con comode e capienti cassettiere interne in finitura canvas come le schiene sp. 6 mm oppure con dei pratici ripiani nello stesso colore della struttura e delle schiene sp. 12 mm.

Two compositional possibilities in order to personalize the wardrobe with comfortable and large inner drawers in canvas color as the th. 6 mm backs or with practical shelves in the same color as the structure and as the th. 12 mm backs.



Armadio Vega Night
con anta vetro Sestante
Struttura: Antracite
Schiene sp. 6 mm e cassettiere
interne Canvas
Anta vetro: Grigio Europa
Illuminazione: led incassato
nei fianchi

Vega night wardrobe
with Sestante glass door
Structure: Antracite
Back th. 6 mm and inner
drawers canvas
Glass door: Grigio Europa
Illumination: led-light
integrated on the sides



Armadio Vega Night
con anta vetro Sestante
Struttura: Antracite
Schiene sp. 12 mm Antracite
Anta vetro: Grigio Europa
Illuminazione:
led incassato nei fianchi

Vega night wardrobe
with Sestante glass door
Structure: antracite
Back th. 12 mm antracite
Glass door: Grigio Europa
Illumination: led-light
integrated on the sides

006 _ comp.

Cabina armadio realizzata con boiserie Fusion attrezzata di ripiani e cassettiere sospese.

Wardrobe cabinet realized with Fusion boiserie with shelves and suspended drawers.

Boiserie Fusion _

Boiserie Fusion

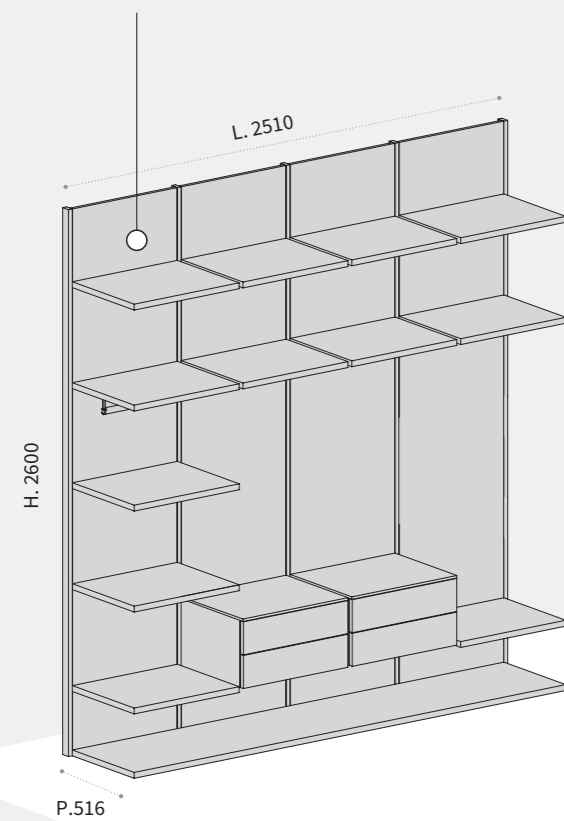

Armadio Vega Night _

Wardrobe

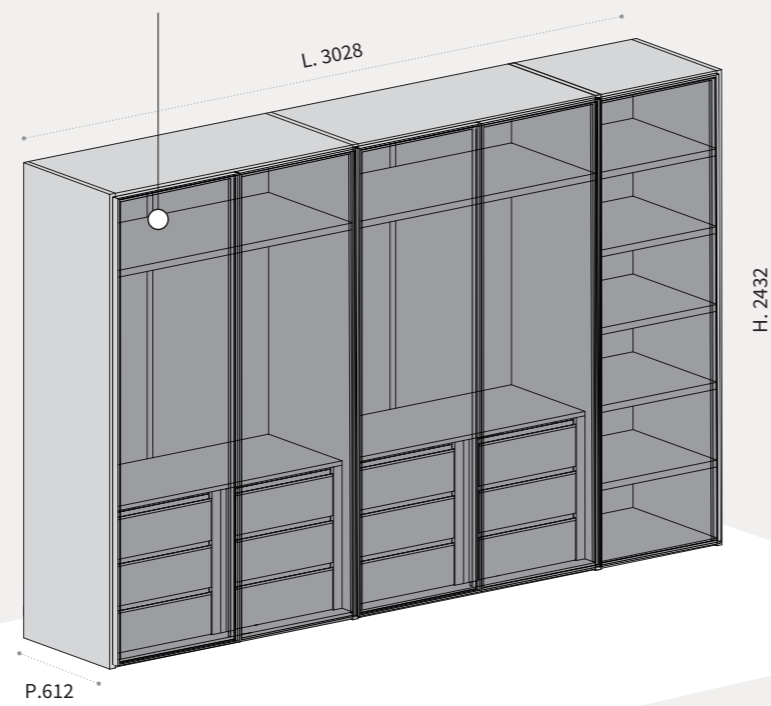

Night Collection

Armadio _

Wardrobe

Armadio Vega Night
con anta vetro Sestante
L. 3028 x P. 612 x H. 2432 mm
Struttura: Antracite
Schiene: 6 mm Canvas
Cassettiere interne: Canvas
Anta Vetro: Grigio Europa
Illuminazione: led incassato
nei fianchi

Vega Night Wardrobe
with Sestante glass door
L.3028 x P.612 x H.2432 mm
Structure: Antracite
Backs: 6 mm Canvas
Inner drawers: Canvas
Glass door: Grigio Europa
Illumination: Led-light integrated
on the sides

Boiserie _

Boiserie Fusion
L. 2510 x P. 516 x H. 2600 mm
Schienali: Noce LLOYD
Mensole e pedana: Antracite
Cassettiere sospese: Antracite
Maniglia: Air 160 Antracite

Fusion boiserie
L. 2510 x D. 516 x H. 2600 mm
Backs: Noce LLOYD
Shelves and platform: Antracite
Suspended drawers: Antracite
Handle: Air 160 Antracite

Finiture
Finishes

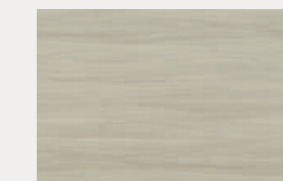

Noce LLOYD



Antracite

Tessuto
Fabric



Cat. B n. 312



Cat. B 325

007 _ comp.

Lo stile diventa funzionale
The style becomes functional



Il pannello porta tv inserito nella colonna polifunzionale si apre, rivelando due ripiani posteriori con una capienza tutta da scoprire.

The TV stand panel inserted on the polifunctional columns open itself revealing two back shelves with the largeness all to discover.



Dalla testata del letto con boiserie Max, esaltata da un'illuminazione led perimetrale, all'angolo home office con scrittoio e comodo pouf: la funzionalità è servita.

From the bed headboard with Max boiserie with a led-light on its perimeter, to the home office corner with desk table and comfortable pouf: the functionality is served.



007 __ comp.

Armadio realizzato con colonne Vega Night con anta Axel e anta in vetro Sestante ed una pratica colonna polifunzionale con ante e cassettoni Axel e pannello porta tv apribile.

Realized wardrobe with Vega Night coloumn with Axel door and Sestante glass door and a practical polifunctional coloumn with Axel doors and drawers and stand TV panel wich can be opened.

Armadio Vega Night __

Wardrobe

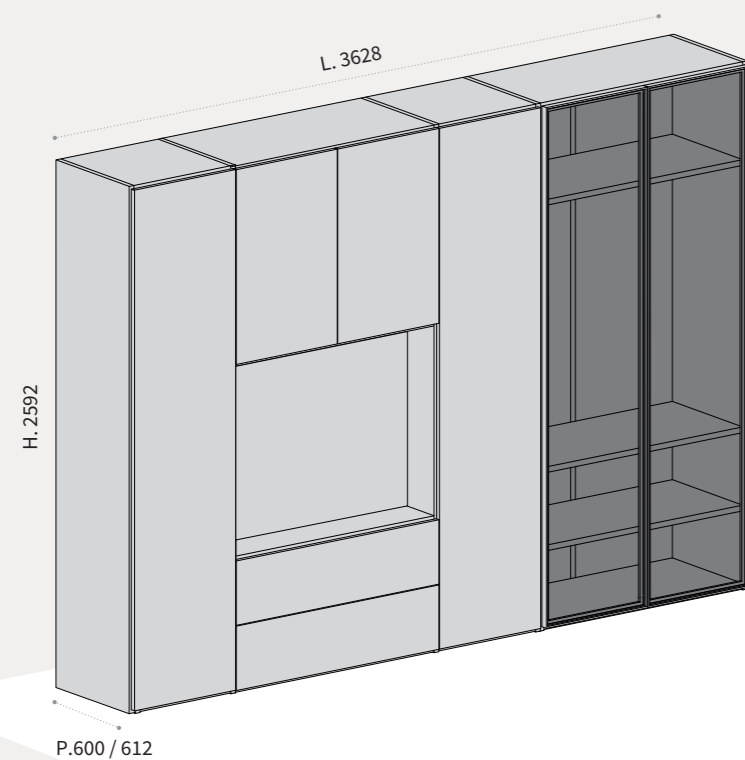

Night Collection

Armadio __

Wardrobe

Armadio Vega Night
con frontali Axel
e anta vetro Sestante
L. 3628 x P.600/612 x H.2592 mm
Struttura: Bianco
Schienali e ripiani colonna
con anta vetro: Noce Cotto
Frontali: Gessato Bianco
Maniglia: Yuky Metal grey
e push-pull
Anta vetro: Grigio Europa
Illuminazione: led incassato
nei fianchi

Vega Night wardrobe
with Axel frontals
and Sestante glass door
L. 3628 x D. 600/612 x H. 2592 mm
Structure: Bianco
Back and coloumns shelves
with glass door: Noce Cotto
Frontals: Gessato Bianco
Handle: Yuky Metal grey
and push-pull
Glass door: Grigio Europa
Illumination: led-light integrated
on the sides

Finiture
Finishes



Bianco

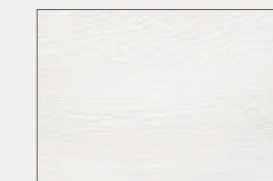

Gessato Bianco

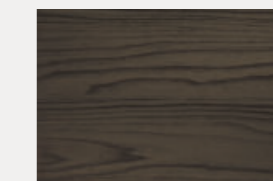

Noce Cotto



Verde Laguna

Tessuto
Fabric



E 56

008 _ comp.

Spazio organizzato
Organized space



Un pratico vano a giorno ospita una cassettoniera capiente e un comodo ripiano inclinato portascarpe: tutto a portata di mano in un unico colpo d'occhio.

A practical open unit accommodates a large drawer and a comfortable inclined shoes-rack shelf: it's all at hand in a unique eye-catcher.



La boiserie Stripe caratterizza la zona del letto, portando il calore di un effetto ispirato alla natura.

Boiserie Stripe characterizes the bed zone carrying the warmth of an effect inspired by the nature.



008 _ comp.

Armadio composto da colonne Vega Night con ante, cassetti e cassettoni Axel, pratici vani a giorno attrezzati con ripiani e portascarpe.

Wardrobe composed by a Vega Night coloumn with Axel doors and drawers, practical elements equipped with shelves and shoes-racks.

Armadio Vega Night _

Wardrobe

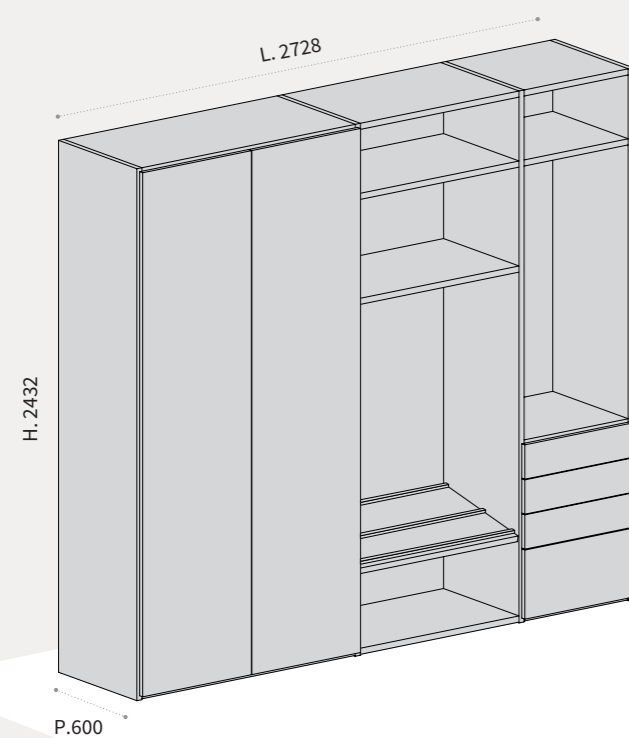

Night Collection

Armadio _

Wardrobe

Armadio Vega Night
con frontali Axel
L. 2728 x P. 600 x H. 2432 mm
Struttura: Sabbia
Frontali: Sabbia
Maniglia: Tesla 96 / 1088 Metal grey
Illuminazione: led incassato
nei fianchi

Vega Night wardrobe
with Axel frontals
L. 2728 x D. 600 x H. 2432 mm
Structure: Sabbia
Frontals: Sabbia
Handle: Tesla 96 / 1088 Metal grey
Illumination: led-light integrated
on the sides

Finiture
Finishes



Sabbia



Salis

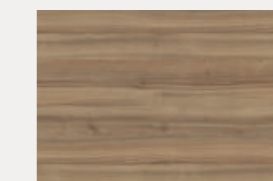

Noce Canaletto

Tessuto
Fabric

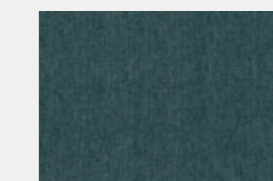

B322

009 _ comp.

Stile funzionale con l'armadio a ponte
Functional style with bridge wardrobe



L'armadiatura a ponte con fianchi sagomati, vano a giorno laterale e scrittoio sospeso Jump: spazio alla leggerezza in camera.

The bridge wardrobe with shaped sides, lateral open unit and suspended desk Jump: space to the lightness in the bedroom.



Night Collection

La combinazione tra gli elementi sospesi e il sistema appendiabiti Pipe offre possibilità compositive sempre diverse, progettate nel segno della leggerezza.

The combination between the suspended elements and the pipe system Pipe offers always different compositional possibilities that are created in the sign of lightness.



009 _ comp.

**Armadio angolare realizzato con colonne attrezzate con ante e cassettoni Axel.
Ponte con ante Axel e spalla terminale sagomata.**

Corner wardrobe realized with coloumns with doors and drawers Axel.
Bridge with Axel doors and terminal shaped shoulder.

Armadio Vega Night _

Wardrobe

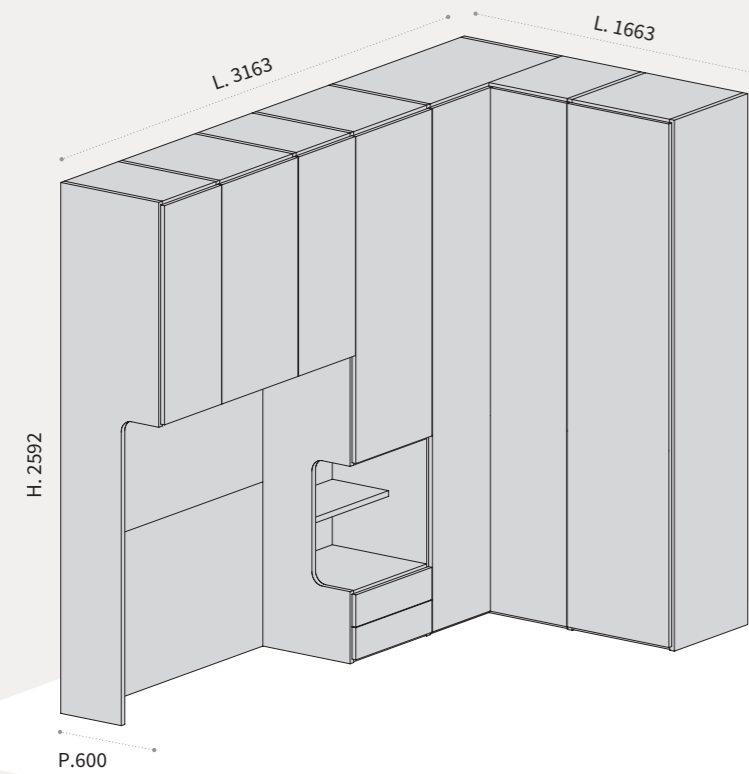

Night Collection

Armadio _

Wardrobe

Armadio e ponte Vega Night
con frontali Axel
L. 3163/1663 x P. 600 x H. 2592 mm
Struttura: Platino
Schienale ponte
e colonna: Luce
Frontali: Platino
Maniglia: Pady 160 Platino
Illuminazione: strip led
nel vano sottoponte

Vega Night Wardrobe
and Bridge with Axel frontals
L. 3163/1663 x D. 600 x H. 2592 mm
Structure: Platino
Back bridge
and coloumn: Luce
Frontals: Platino
Handle: Pady 160 Platino
Illumination: led-light on
the element under the bridge

Finiture
Finishes

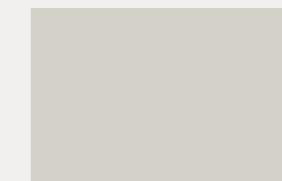

Platino



Luce

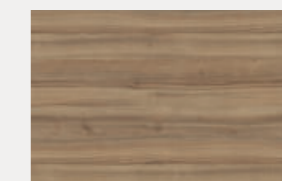

Noce Canaletto

Tessuto
Fabric

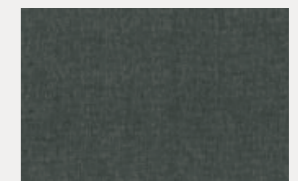

B 327



010 _ comp.

Tante possibilità contenitive

Lots of containing possibilities

Che si tratti di una colonna con anta a tutt'altezza o di una colonna con ante divise, la diversa modularità permette di sfruttare ogni centimetro per contenere tutto il necessario.

The different modularity permits to use every centimeter to contain all the necessary even if it's a column with a floor-to-ceiling door or if it's a column with divided doors.





La cabina armadio è composta da diversi elementi: dalla capiente cassettera in centro stanza all'armadio ad angolo con nicchia.

The wardrobe cabinet is composed by different elements: from the large drawer in the center of the room, to the corner wardrobe with niche.

010 _ comp.

Armadio angolare composto da colonne Vega Night con ante Axel e terminale con ripiani e anta.

Corner wardrobe composed by Vega Night columns with Axel doors and terminal element with shelves and door.

Armadio Vega Night _

Wardrobe

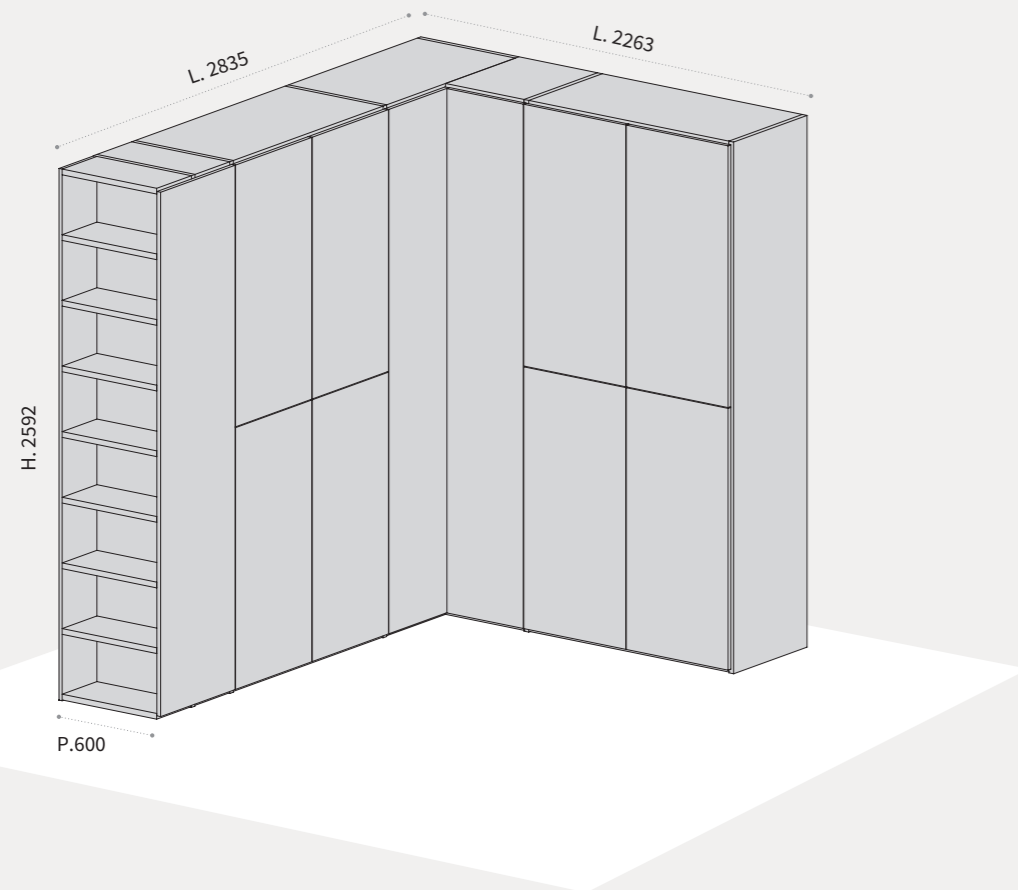

Night Collection

Armadio _

Wardrobe

Armadio Vega Night
con frontali Axel
L. 2835/2263 x P. 600 x H. 2592 mm
Struttura: Grigio Londra e Noce Cotto
Frontali: Grigio Londra
Maniglia: Push-pull

Vega Night wardrobe
with Axel frontals
L. 2835/2263 x D. 600 x H. 2592 mm
Structure: Grigio Londra and Noce Cotto
Frontals: Grigio Londra
Handle: Push-pull

Finiture
Finishes

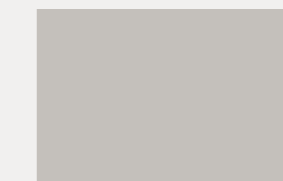

Grigio Londra

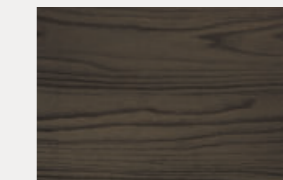

Noce Cotto

Tessuto
Fabric



F137

011 _ comp.

La stanza si veste di colore
The room dresses itself with color



Night Collection

Abiti, accessori, oggetti che raccontano storie e momenti legati al quotidiano: l'armadio come custode di piccoli segreti tutti da svelare.

Clothes, accessories, objects that tell stories and daily moments: the wardrobe as a keeper of little secrets that have to be told.



La pratica presa della maniglia Omega rende cassetti e cassettoni funzionali, oltre che di tendenza.

The practical grip of the Omega handle makes the drawers functional and trendy

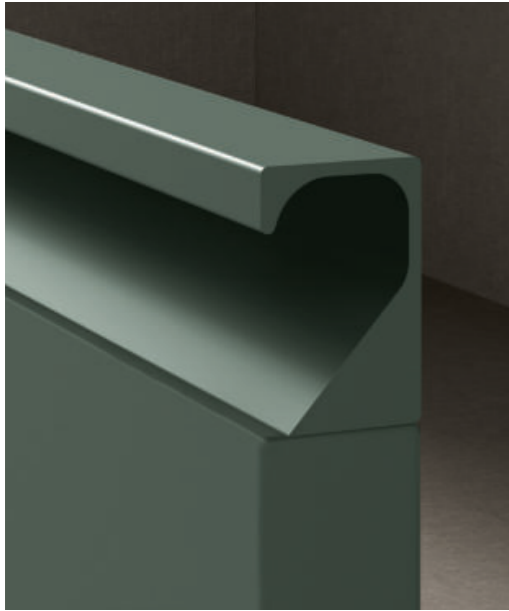

011 _ comp.

**Armadio composto da colonne Vega Night con ante, cassetti e cassettoni Omega.
La colonna centrale con vano a giorno e la colonna a destra sono dotate di ante Axel.**

Wardrobe composed by a Vega Night coloumn with Omega doors and drawers.
The central coloumn with open element and the coloumn on the right side have Axel doors.

Armadio Vega Night _

Wardrobe

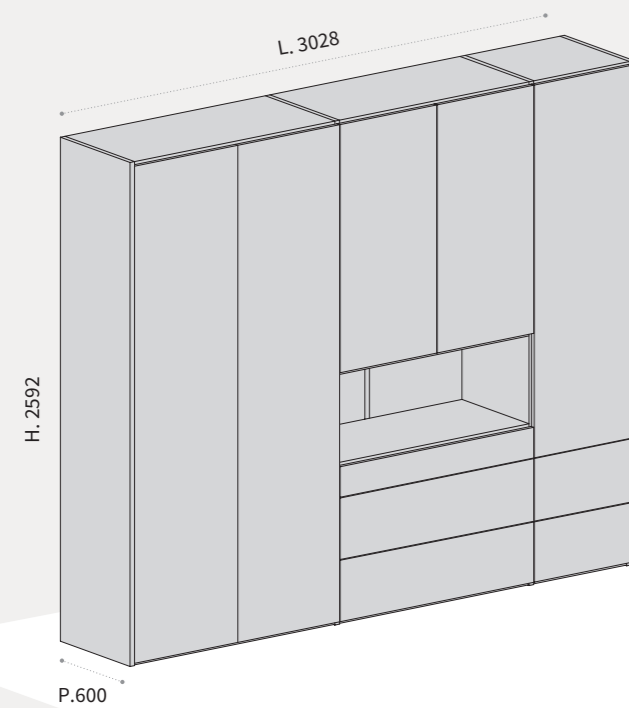

Night Collection

Armadio _

Wardrobe

Armadio Vega Night
con frontali Axel e Omega
L. 3028 x P. 600 x H. 2592 mm
Struttura: Verde Laguna
Schienali e ripiani interni: Madreperla
Frontali: Verde Laguna
Maniglia: Push-pull
Profili maniglia: Verde Laguna
Illuminazione: lampada Blade

Vega Night wardrobe
with Axel and Omega frontals
L. 3028 x D. 600 x H. 2592 mm
Structure: Verde Laguna
Back and inner shelves: Madreperla
Frontals: Verde Laguna
Handle: Push-pull
Handle profiles: Verde Laguna
Illumination: Blade light

Finiture

Finishes



Verde Laguna

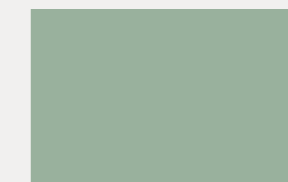

Menta

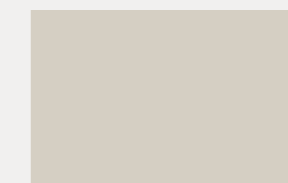

Madreperla

Tessuto

Fabric



B 317

012 _ comp.

L'armadio con anta a specchio
The wardrobe with the mirror door



Il plus della colonna a giorno, che ospita un pratico ripiano portascarpe completato da illuminazione a led integrata sui fianchi.

The fantastic open column that hosts a practical shoes-rack shelf completed with led-light integrated on the sides.



012 _ comp.

Composizione angolare realizzata con arredi Vega Night con anta Unica laccata e anta Unica a specchio, oltre a una colonna a giorno con ripiani portascarpe. Sul lato sinistro, capienti colonne a giorno Vega Day con ripiani in legno e ripiani in vetro retroilluminati.

Corner composition created with Vega Night furnishing with Unica lacquered door and Unica mirror door and one open coloumn with shoes-rack shelves. On the left side, large open Vega Day coloumns with wooden shelves and glass shelves with light on the back.

Armadio Vega Night _

Wardrobe

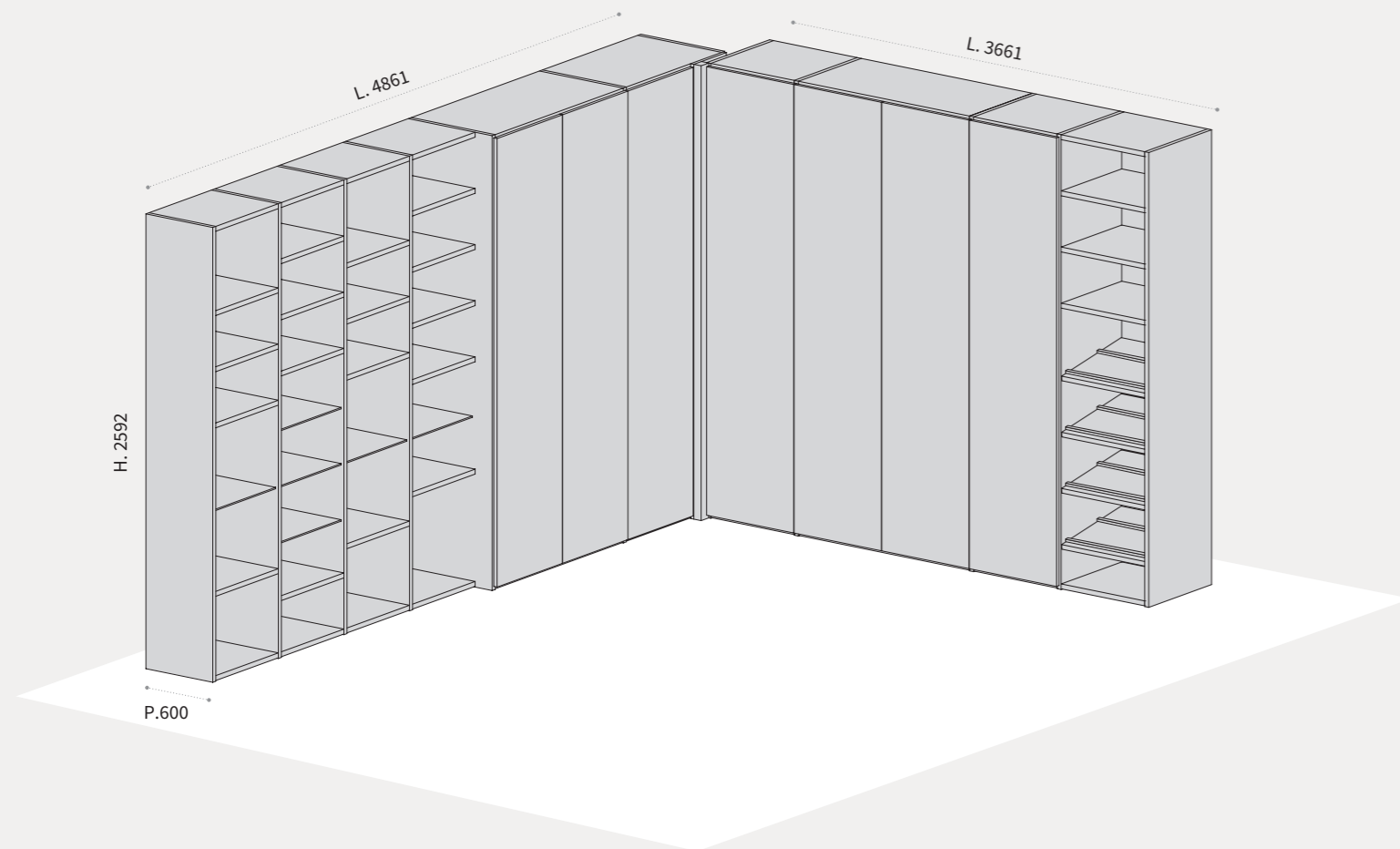

Night Collection

Armadio _

Wardrobe

Armadio Vega Night
con frontali Unica
Colonne a giorno Vega Day
L. 4861/3661 x P. 600 x H. 2592 mm
Struttura: Grafite
Frontali: Madreperla
e Specchio Argentato
Profili anta: Madreperla e Grafite
Illuminazione: led incassato
nei fianchi
Lampada Reflex su ripiani vetro

Vega Night wardrobe
with Unica frontals
Open Vega Day coloumns
L. 4861/3661 x D. 600 x H. 2592 mm
Structure: Grafite
Frontals: Madreperla
and Silver mirror
Door profiles: Madreperla and Grafite
Illumination: led-light integrated
on the sides
Reflex lamp on glass shelves

Finiture
Finishes

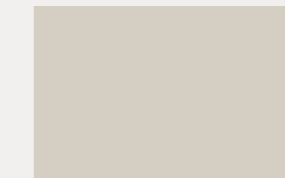

Madreperla

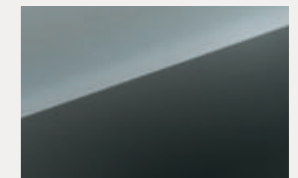

Specchio argentato



Grafite

Tessuto
Fabric



Cat. B n. 325

013 _ comp.

La funzionalità si veste di design
The functionality dresses itself with design



Una camera dai tratti semplici che coniuga lo stile alla qualità. Il modulo di passaggio rivela uno spazio comodo, ordinato e capiente.

A bedroom with simple sections that join the style to the quality. The passing module reveals a comfortable space, ordered and large.



013 _ comp.

Armadio realizzato con colonne e modulo di passaggio Vega Night con anta Unica.

Wardrobe created with Vega Night columns and passing modules with Unica door.

Armadio Vega Night _

Wardrobe

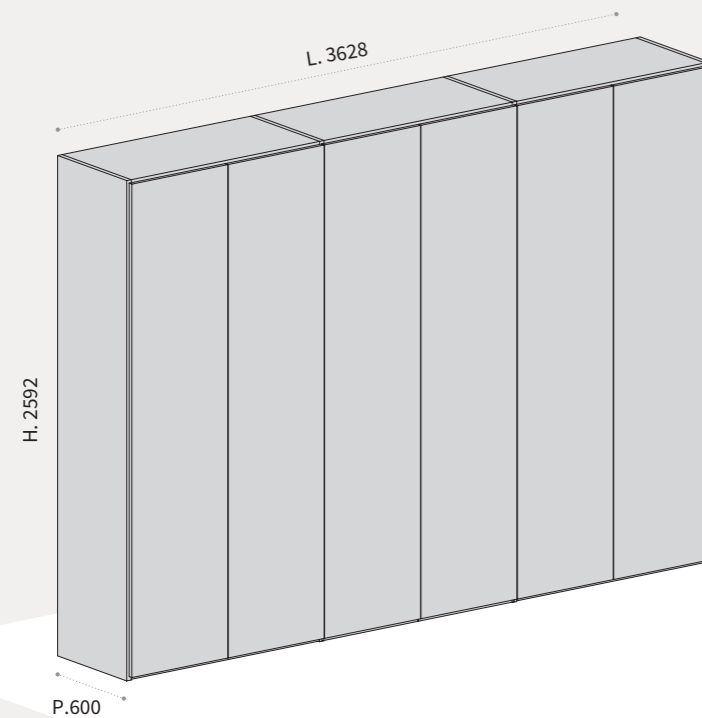

Night Collection

Armadio _

Wardrobe

Armadio Vega Night
con frontali Unica
L. 3628 x P. 600 x H. 2592 mm
Struttura: Grigio Cenere
Frontali: Grigio Cenere
Profili anta: Grigio Cenere

Vega Night wardrobe
with Unica frontals
L. 3628 x D. 600 x H. 2592 mm
Structure: Grigio Cenere
Frontals: Grigio Cenere
Door profiles: Grigio Cenere

Finiture
Finishes



Grigio Cenere

Tessuto
Fabric



Cat. F n. 22



014 _ comp.

Soluzione salvaspazio con l'armadio di passaggio
Space-saving solution with the passing wardrobe



Il letto a scomparsa è un'ottima alternativa per chi ha poco spazio, ma non vuole rinunciare all'ospitalità comoda e di design.

The disappearance-bed is an optimal alternative for those who have little space and don't want to give up to a comfortable and trendy hospitality.





Il modulo di passaggio che caratterizza Vega Night permette di creare una connessione tra aree diverse, ampliando lo spazio dedicato al contenimento.

The passing module that characterizes Vega Night permits to create a connection between different areas giving more space which is dedicated to the containment.

Night Collection

Interni attrezzati e organizzati: cassettiere e ripiani permettono di organizzare al meglio gli interni dell'armadio, ottimizzando tutto lo spazio.

Organised, fully fitted interiors: drawer units and shelves help you to organise the inside of your wardrobe, optimising all of the available space.



Nel programma Vega Night il modulo di passaggio è disponibile in due diverse soluzioni: con passaggio a giorno e ante superiori oppure con anta a tutt'altezza.

On the Vega Night programm the passing module is available in two different solutions: with open passing element and superior doors or with floor-to-ceiling door.



Armadio Vega Night
con frontali Axel
L. 3628 x P.600 x H.2912 mm
Struttura: Grigio Cenere
Frontali: Grigio Cenere
Maniglia: Push-pull e
Tassello 1088 Grigio Cenere

Vega Night wardrobe
with Axel frontals
L. 3628 x D. 600 x H. 2912 mm
Structure: Grigio Cenere
Frontals: Grigio Cenere
Handle: Push-pull
and Tassello 1088 Grigio Cenere



Armadio Vega Night
con frontali Axel
L. 3628 x P.600 x H.2912 mm
Struttura: Grigio Cenere
Frontali: Grigio Cenere
Maniglia: Tassello 1088
Grigio Cenere

Vega Night wardrobe
with Axel frontals
L. 3628 x D. 600 x H. 2912 mm
Structure: Grigio Cenere
Frontals: Grigio Cenere
Handle: Tassello 1088
Grigio Cenere

014 _ comp.

Composizione con colonne armadio, modulo di passaggio Vega Night e colonna a giorno Vega Day con anta Axel. Elemento Vega con letto e divano a scomparsa, penisola e dettaglio retroletto con contenitore.

Composition with wardrobe columns, passing Vega Night module and open Vega Day column with Axel door. Vega element with disappearance bed and sofa, peninsula and detail of the behind of the bed with container.

Armadio Vega Night _

Wardrobe

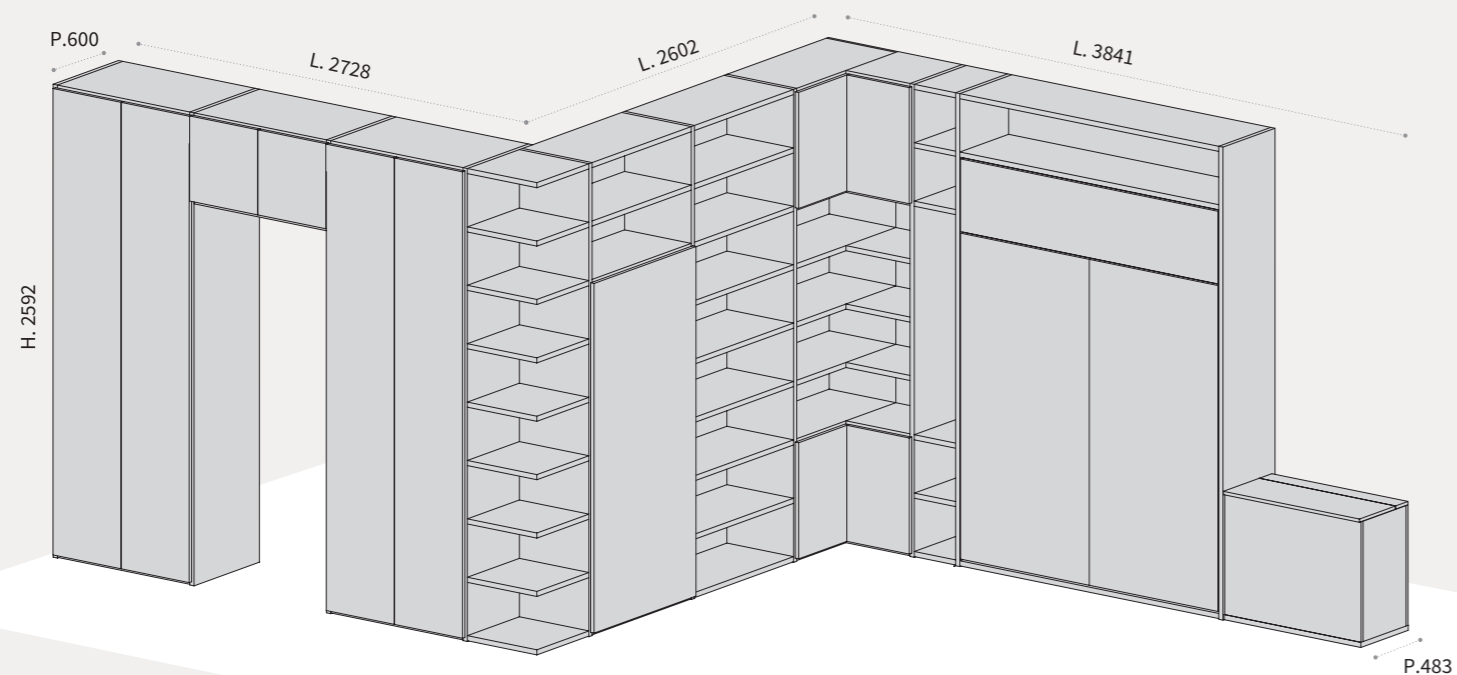

Night Collection

Armadio _

Wardrobe

Armadio Vega Night
con frontali Axel
Librerie ed elemento con letto
a scomparsa Vega Day
con frontali Axel
L. 2728/2602/3841 x
P.483/600 x H.2592 mm
Struttura: Noce Lloyd
Frontali: Fango
Maniglia: Tassello 160/1088
Fango e push-pull
Tessuto: E56

Vega Night wardrobe
with Axel frontals
Library and Vega Day
element with disappearance
bed with Axel frontals
L. 2728/2602/3841 x
P 483/600 x H.2592 mm
Structure: Noce Lloyd
Frontals: Fango
Handle: Tassello 160/1088
Fango and Push-pull
Fabric: E56

Finiture
Finishes

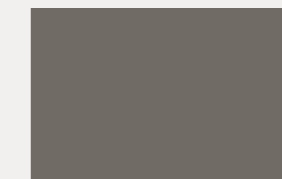

Fango

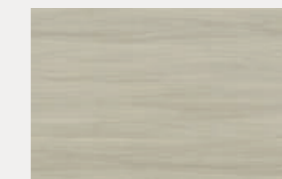

Noce Lloyd

Tessuto
Fabric



E56

015 _ comp.

Impronta personalizzata
Personalized sign

L'armadiatura a ponte
si arricchisce di
elementi contenitivi
per sfruttare al meglio
gli spazi disponibili.

Bridge wardrobe enriched itself of containing elements
to use all the available space in a better way



Dall'unione tra gli elementi Vega Day e Vega Night nascono spazi confortevoli, come le composizioni a ponte con libreria ed elemento con letto e divano a scomparsa.

The union of Vega Day and Vega Night elements gives birth to comfortable spaces, as the bridge compositions with library and disappearance bed and sofa element.



015 _ comp.

Composizione realizzata con colonne, ponte e terminale obliquo Vega Night dotato di anta. Elemento Vega con letto e divano a scomparsa e colonne a giorno Vega Day. Nel vano sottoponte, basi Vega Day P. 600 mm con anta Axel.

Composition realized with coloumns, bridge and inclined Vega Night terminal element with door. Vega element with disappearance bed and sofa and open Vega Day coloumns. On the element under the bridge, Vega Day bases D. 600 mm with Axel door.

Armadio Vega Night _

Wardrobe

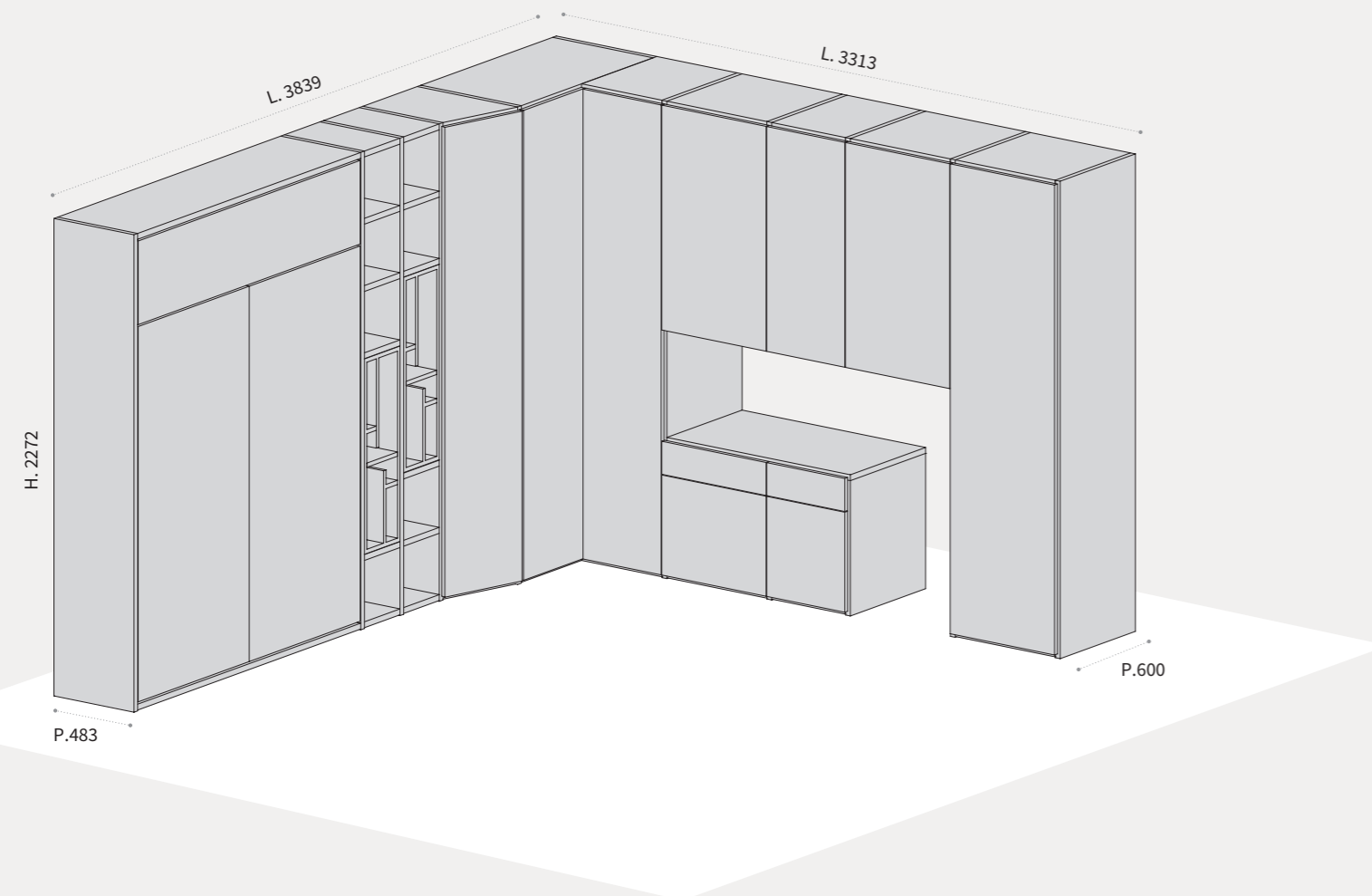

Night Collection

Armadio _

Wardrobe

Armadio e ponte Vega Night con frontali Axel
 Librerie ed elemento con letto a scomparsa Vega Day con frontali Axel
 L. 3839/3313 x
 P. 483/600 x H. 2272 mm
 Struttura: Noce Sider
 Frontali: Grafite
 Elementi Kubik: Grafite
 Maniglia: Pady 160 Piombo
 Tessuto: B 325

Wardrobe and bridge Vega Night with Axel frontals
 Libraries and element with disappearance Vega Day bed with Axel frontals
 L. 3839/3313 x
 P. 483/600 x H. 2272 mm
 Structure: Noce Sider
 Frontals: Grafite
 Kubik Elements: Grafite
 Handle: Pady 160 Piombo
 Fabric: B 325

Finiture
 Finishes



Grafite

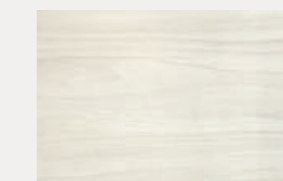

Noce Sider

Tessuto
 Fabric



B 325

016 _ comp.

Armadiature di servizio

Service wardrobes



Lo spazio lavanderia deve essere comodo: elementi come colonne attrezzate con ripiani oppure a tutt'altezza garantiscono versatilità e capienza.

The laundry space has to be comfortable: elements with shelves or floor-to-ceiling guarantee versatility and largeness.



Tutto ciò che riguarda l'ordine della casa trova organizzazione in armadiature personalizzabili in base alle proprie esigenze.

All that is about the order of the home finds organisation into the personalized wardrobes based on proper needs.



L'anta ripostiglio, senza schiena e senza fianchi, è ideale per sfruttare al meglio tutti gli spazi e per contenere apparecchi di servizio, come per esempio la caldaia.

The closet door, without sides and back, is optimal to use all the spaces in a better way to contain services objects, as for ex. The boiler.

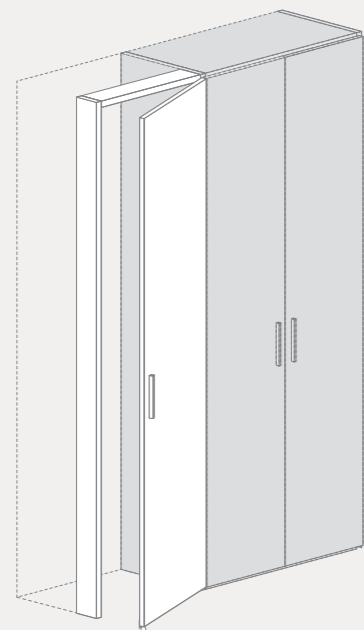

Tre diverse possibilità compositive dedicate alla zona lavanderia, con colonna coprilavatrice ed elementi con anta o a giorno per contenere e ordinare senza rinunciare al design.

Three different composing possibilities dedicated to the laundry zone with cover-washing machine column and door elements or open elements to contain and order without giving up the design.



Soluzione con colonna coprilavatrice e basi Vega Day a giorno e con frontali Axel
L. 3028 x P.600 x H.992/2272 mm
Struttura: Fango
Frontali: Bianco
Maniglia: Pady 160/320 Bianco

Solution with cover- washing machine column and open Vega Day bases or with Axel door
L. 3028 x P. 600 x H. 992/2272 mm
Structure: Fango
Frontals: Bianco
Handle: Pady 160/320 Bianco



Soluzione con colonna armadio, colonna a giorno e colonna coprilavatrice con frontali Axel
L. 2728 x P.600 x H.2272 mm
Struttura: Fango
Frontali: Bianco
Maniglia: Pady 320 Bianco

Solution with wardrobe column, open column and cover-washing machine column with Axel doors
L. 2728 x P. 600 x H.2272 mm
Structure: Fango
Frontals: Bianco
Handle: Pady 160/320 Bianco



Soluzione con colonne armadio con frontali Axel e coprilavatrice realizzato con top e fianco sp. 56 mm
L. 3170 x P.600 x H.976/2272 mm
Struttura: Fango
Frontali: Bianco
Maniglia: Pady 320 Bianco

Solution with wardrobe column with Axel doors and cover- washing machine column realized with top and side th. 56 mm
L. 3170 x P. 600 x H. 976/2272 mm
Structure: Fango
Frontals: Bianco
Handle: Pady 160/320 Bianco

016 _ comp.

Composizione per zona lavanderia con colonna coprilavatrice, anta ripostiglio e colonne Vega Night attrezzate con ante, cassetti e cassettoni Omega.

Composition for laundry zone with cover- washing machine columns, closet door and Vega Night columns with Omega doors and drawers.

Armadio Vega Night _

Wardrobe

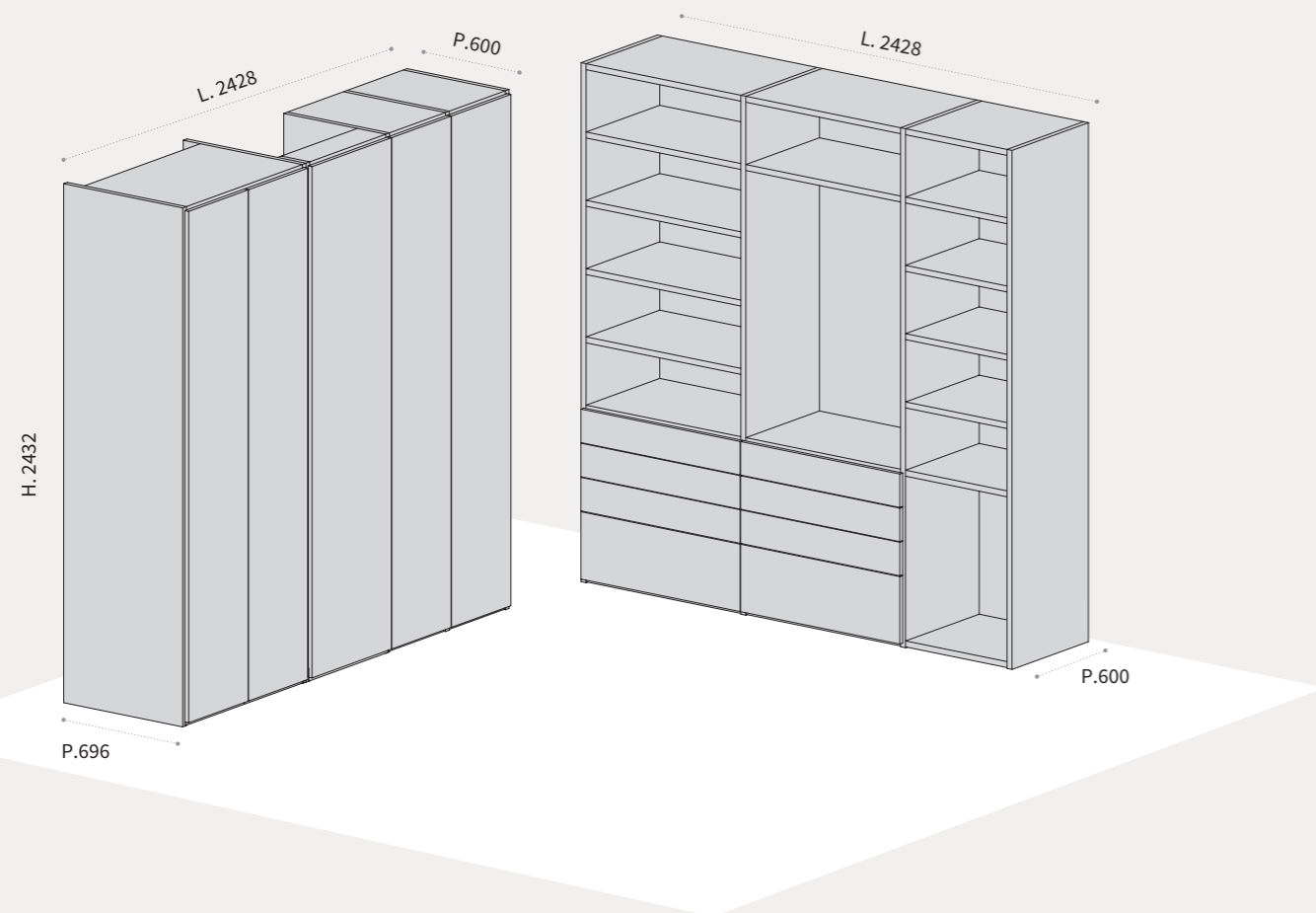

Night Collection

Armadio _

Wardrobe

Armadio Vega Night
con frontali Omega
L. 2428/2428 x P. 600/696
x H. 2432 mm
Struttura: Bianco
Frontali: Bianco
Profili maniglia: Bianco

Vega Night wardrobe
with Omega frontals
L. 2428/2428 x D. 600/696
x H. 2432 mm
Structure: Bianco
Frontals: Bianco
Handle profiles: Bianco

Finiture
Finishes

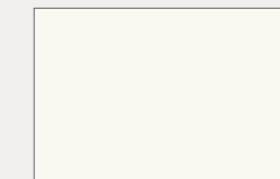

Bianco



VEGA NIGHT__

Dettagli tecnici e finiture
Technical details and finishes

STRUTTURA VEGA NIGHT

Caratteristiche generali e finiture / General features and finishes

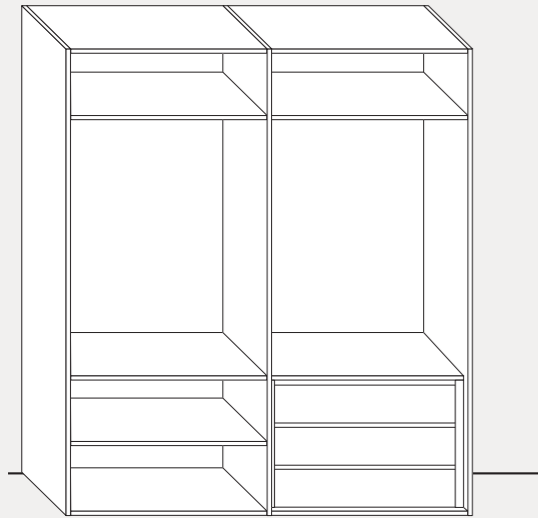

| Componenti Components | Spessore Thickness |
|--------------------------|---------------------------|
| Spalle (Shoulders) | 2,8 cm |
| Coperchio (Lid) | 2,8 cm |
| Base (Base) | 2,8 cm |
| Ripiano (Shelf) | 2,8 cm |
| Schiena (Back) | 0,6 cm (1,2 cm opzionale) |

Nobilitati disponibili per struttura (spalle, coperchi, basi, ripiani e schiene sp. 1,2 cm)
Melamine available by structure (sides, lids, bases, shelves and backs 1.2 cm thick)

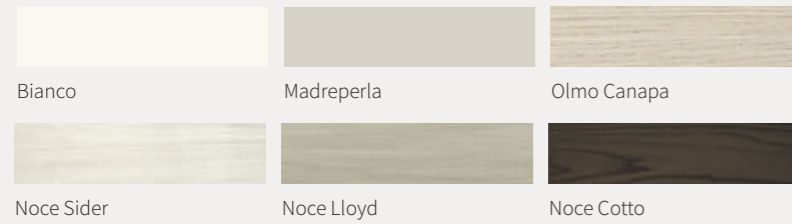

Laccati opachi, lucidi, metal

Matt, glossy, metal lacquered



Nobilitati per schiene sp. 0,6 cm e cassettiere interne

Melamine for backs th. 0.6 cm and internal drawers

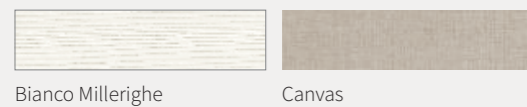

MODULARITÀ VEGA NIGHT

Modularity

Prof. **60 cm** (compresi frontali - fronts included)

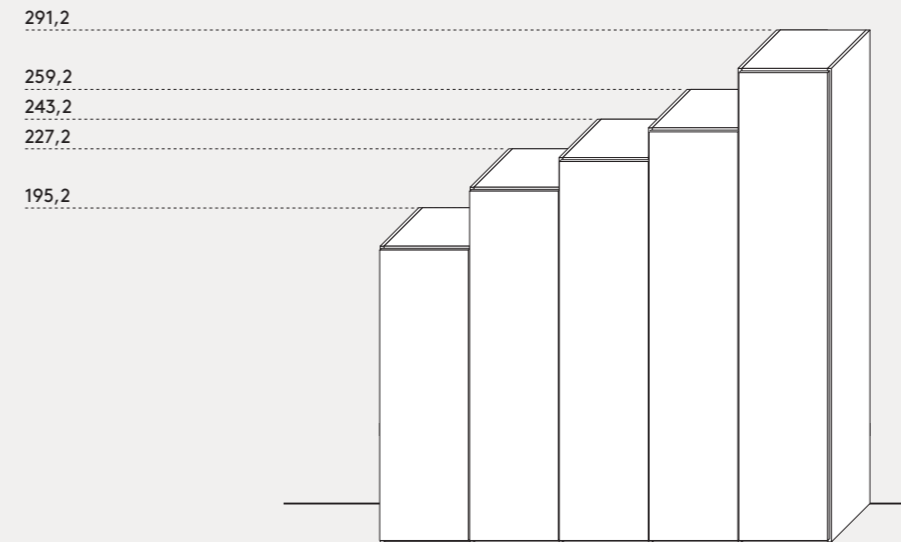

Larghezze (compresa spalla sx)

Profondità (compresi frontali)

Widths (left side included)

Depths (fronts included)

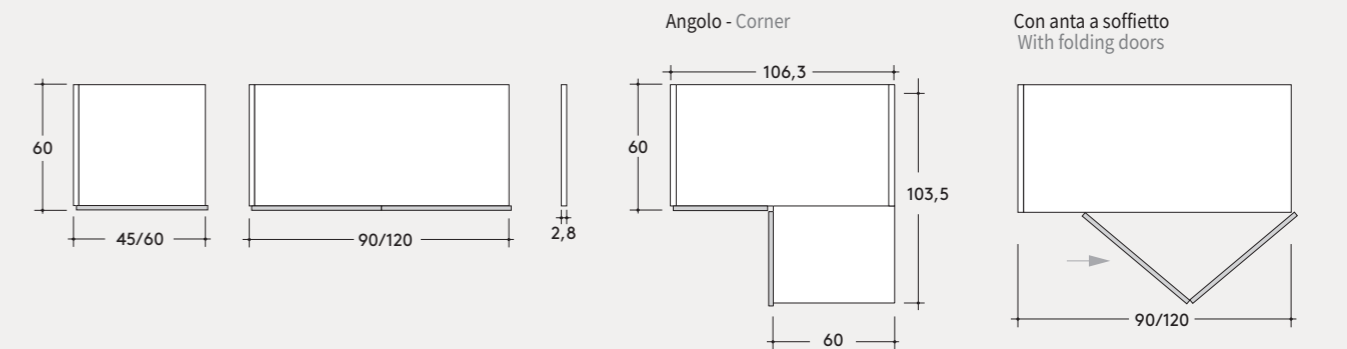

Angolo con pannello fisso e compensatore

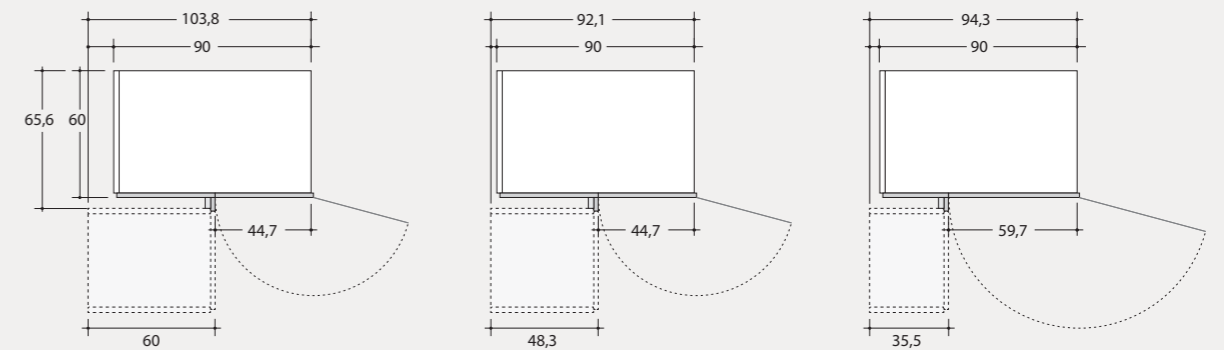

Terminale obliquo

Oblique terminal

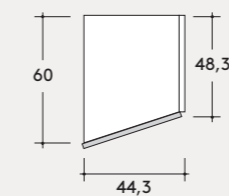

Terminale con anta e ripiani

Terminal with shelves and door

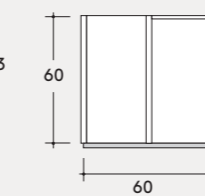

Terminale con ripiani stondati

Terminal with rounded-edge shelf



Coprilavatrice (escluso altezza 291,2)

Washing machine cabinet (291.2 cm height excluded)

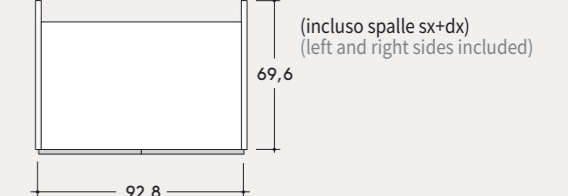

FRONTALI VEGA NIGHT

Tipologie / Fronts Types

Soluzioni dove al design delle ante si unisce la funzionalità dei volumi. Con i giochi di finiture e di materiali, di geometrie e di prese maniglia, l'armadio scopre eleganza e comodità in un'unica forma.

Solutions where the design of the doors is in perfect harmony with the functionality of the space offered. With combinations of finishes and materials, of geometries and handles, the wardrobe attains a unique level of elegance and comfort.

**AXEL****Modularità**

L 42,2 cm
L 57,2 cm
L 87,2 cm (ante 45+45)
L 117,2 cm (ante 60+60)
Elementi angolo
Terminale con ripiani e anta
Terminale obliquo
Ponti

Modularity

L 42.2 cm
L 57.2 cm
L 87.2 cm (45 + 45 doors)
L 117.2 cm (60 + 60 doors)
Corner elements
Terminal with shelves and door
Oblique terminal
Bridges

Tipologie di frontale / Types of fronts

ANTE BATTENTI / Wing doors
CASSETTI / Drawers
CASSETTONI / Big drawers

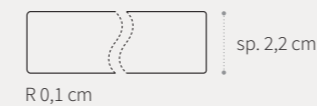
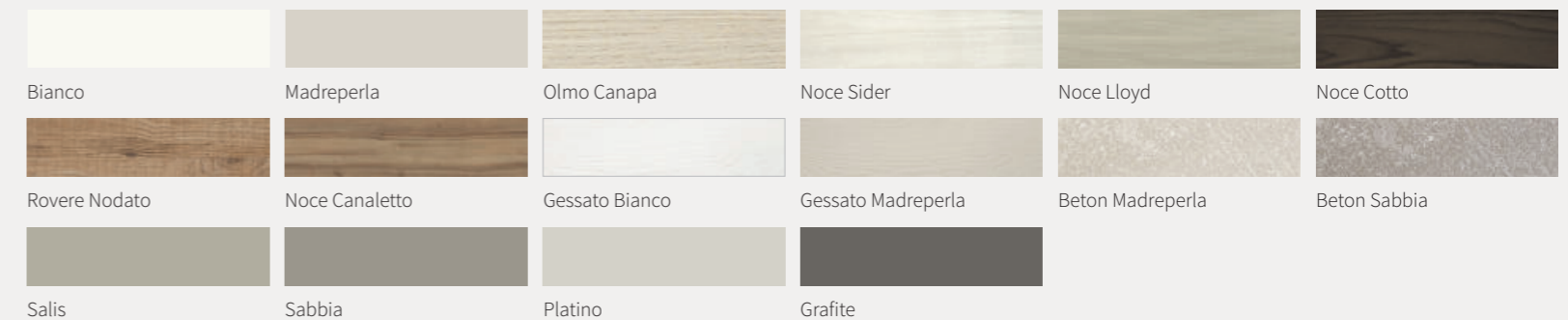
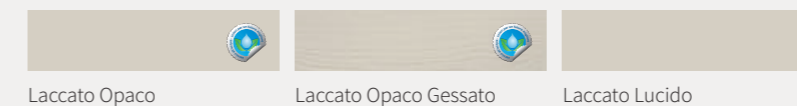
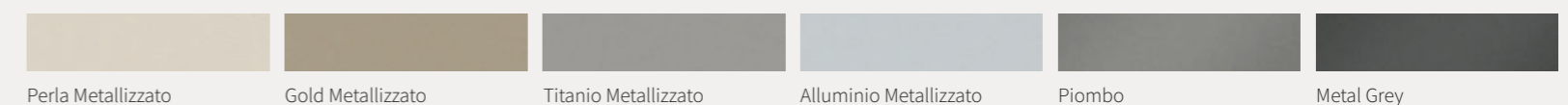
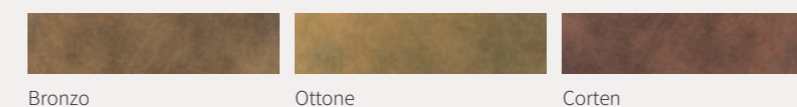
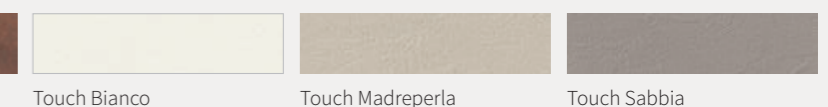
Sezione anta / Door section**Nobilitati - Melamines****Laccati - Lacquered****Laccati Metal - Metal lacquer****Iron****Touch**

Sezione anta / Door section

FRONTALI VEGA NIGHT

Tipologie / Fronts Types

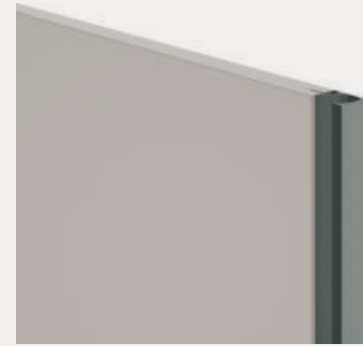

OMEGA

Modularità

L 42,2 cm (solo anta)
L 57,2 cm
L 87,2 cm (ante 45+45)
L 117,2 cm (ante 60+60)
Elementi angolo
Terminale obliquo

Modularity

L 42.2 cm (door only)
L 57.2 cm
L 87.2 cm (45 + 45 doors)
L 117.2 cm (60 + 60 doors)
Corner elements
Oblique terminal

Tipologie di frontale / Types of fronts

ANTE BATTENTI / Wing doors
CASSETTI / Drawers
CASSETTONI / Big drawers

Finiture profili
Profile finishes

Piombo (di serie)
Bianco (di serie)
Laccati Opachi
Laccati Lucidi
Laccati Metal

Sezione anta / Door section

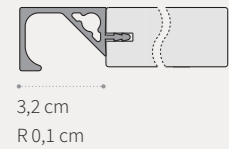

3,2 cm
R 0,1 cm

Sezione cassetto/cassettone / Drawer section

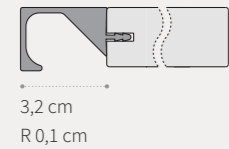

3,2 cm
R 0,1 cm

sp. 2,2 cm

Nobilitati - Melamines

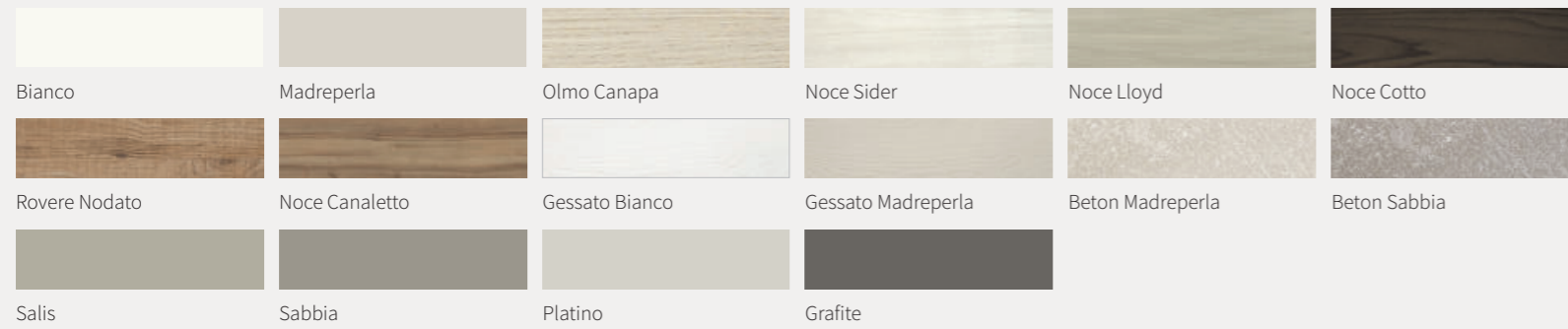

Laccati - Lacquered



Laccati Metal - Metal lacquer

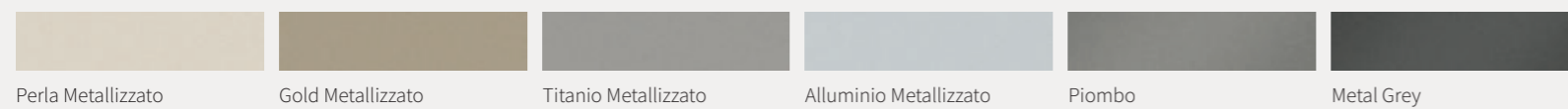

Per le dimensioni disponibili fare riferimento al listino prezzi / For available sizes, refer to the price list



UNICA

Modularità

L 42,2 cm
L 57,2 cm
L 87,2 cm (ante 45+45)
L 117,2 cm (ante 60+60)
Elementi angolo
Terminale obliquo

Modularity

L 42.2 cm
L 57.2 cm
L 87.2 cm (45 + 45 doors)
L 117.2 cm (60 + 60 doors)
Corner elements
Oblique terminal

Tipologie di frontale / Types of fronts

ANTE BATTENTI / Wing doors

Finiture profili
Profile finishes

Piombo (di serie)
Bianco (di serie)
Laccati Opachi
Laccati Lucidi
Laccati Metal

Sezione anta / Door section

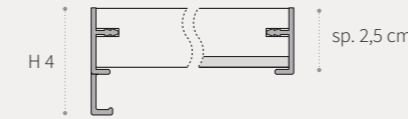

H 4

sp. 2,5 cm

Nobilitati - Melamines

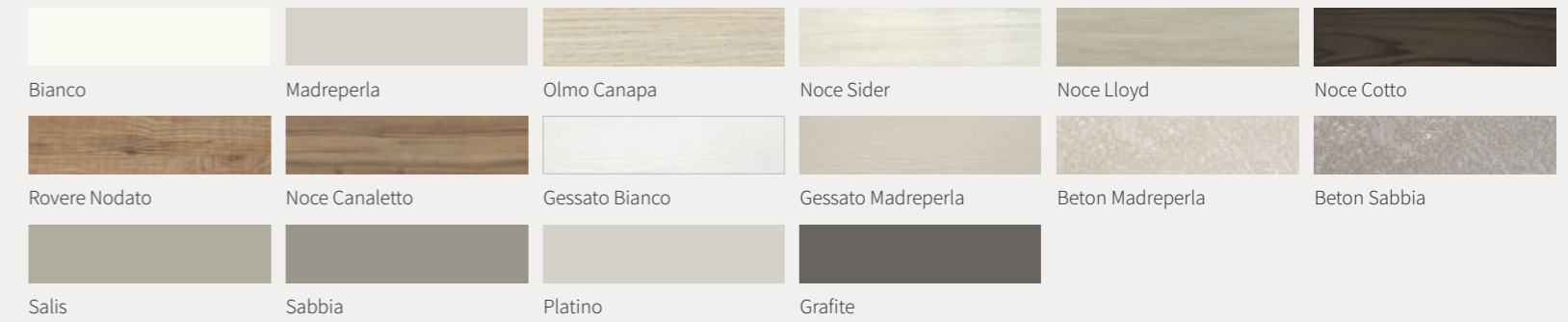

Laccati - Lacquered

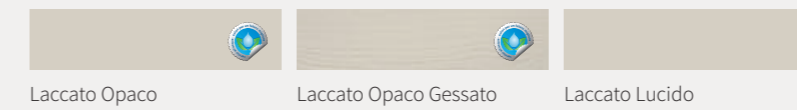

Laccati Metal - Metal lacquer

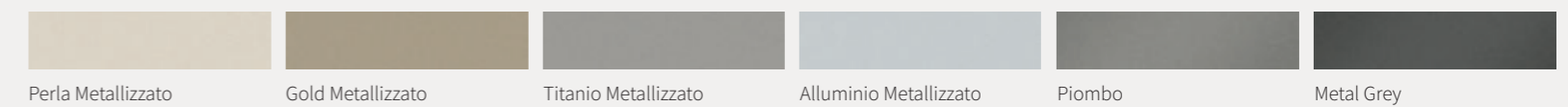

Specchio - Mirror

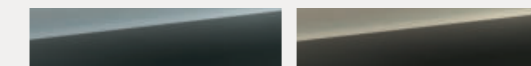

Argentato

Brunito

Per le dimensioni disponibili fare riferimento al listino prezzi / For available sizes, refer to the price list

FRONTALI VEGA NIGHT

Tipologie / Fronts Types

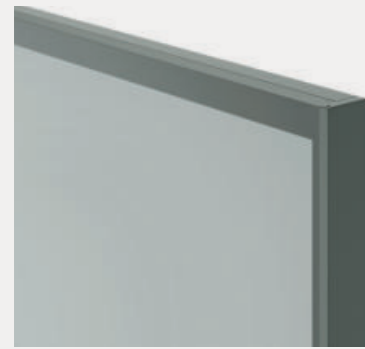

ANTA SESTANTE GLASS DOOR

Modularità

L 42,2 cm
L 57,2 cm
L 87,2 cm (ante 45+45)
L 117,2 cm (ante 60+60)

Modularity

L 42.2 cm
L 57.2 cm
L 87.2 cm (45 + 45 doors)
L 117.2 cm (60 + 60 doors)

Tipologie di frontale / Types of fronts

ANTE BATTENTI / Wing doors

Sezione anta / Door section

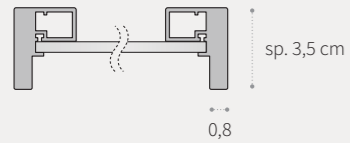

Vetro - Glass



Grigio Europa

Telaio - Frame

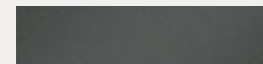

Metal Grey



ANTA VETRO GLASS DOOR

Modularità

L 42,2 cm
L 57,2 cm
L 87,2 cm (ante 45+45)
L 117,2 cm (ante 60+60)

Modularity

L 42.2 cm
L 57.2 cm
L 87.2 cm (45 + 45 doors)
L 117.2 cm (60 + 60 doors)

Tipologie di frontale / Types of fronts

ANTE BATTENTI / Wing doors

Sezione anta / Door section

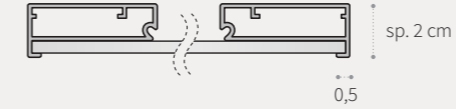

Vetro - Glass

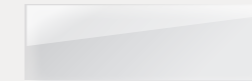

Trasparente



Grigio Europa

Vetri laccati lucidi - Glossy lacquered glass

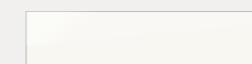

Bianco



Platino



Madreperla



Salis



Sabbia



Fango



Grigio Londra



Grigio Cenere



Grafite



Antracite

Telaio - Frame

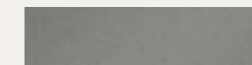

Piombo

ORGANIZZAZIONE DEGLI INTERNI

Interior organization



A
2 ripiani
2 tubi appendiabiti
1 cassetiera interna con 2 cassetti
2 shelves
2 coat-hangers
1 inner drawer with 2 drawers

B
1 ripiano largo
3 ripiani stretti
2 tubi appendiabiti
1 tramezza interna
1 large shelf
3 close shelves
1 coat-hangers
1 inner side

C
4 ripiani
2 ripiani inclinati portascarpe
4 shelves
2 inclined shoes rack shelves

D
2 ripiani
1 crociera interna
1 cassetiera interna con 3 cassetti
1 servetto estraibile
2 shelves
1 inner cruiser
1 inner drawer with 3 drawers
1 removable "servetto"

E
2 ripiani
1 tubo appendiabiti
1 cassetiera interna con 6 cassetti
2 shelves
1 coat-hanger
1 inner drawer with 6 drawers

F
4 ripiani
1 tubo appendiabiti
4 shelves
1 coat-hanger

G
2 ripiani larghi
3 ripiani stretti
1 tubo appendiabiti
1 tramezza interna
1 cassetiera interna con 2 cassetti
2 shelves
3 close shelves
1 coat-hanger
1 inner side
1 inner drawer with 2 drawers

H
4 ripiani
1 tubo appendiabiti
4 shelves
1 coat-hanger

I
2 ripiani
1 tubo appendiabiti
2 shelves
1 coat-hanger

L
2 ripiani
1 servetto estraibile
1 portapantaloni estraibile
2 shelves
1 removable "servetto"
1 removable trousers rack

M
2 ripiani
2 tubi appendiabiti
2 shelves
2 coat-hangers

ESEMPI DI ORGANIZZAZIONE INTERNA DEGLI SPAZI (proposte su colonna H 259,2 cm)

Examples of internal organization of spaces (proposals on H 259,2 cm column)

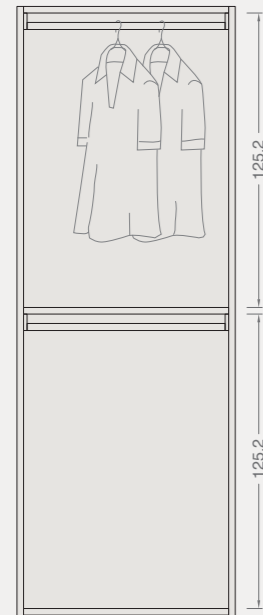

1 ripiano
2 tubi appendiabiti
1 shelf
2 coat-hangers

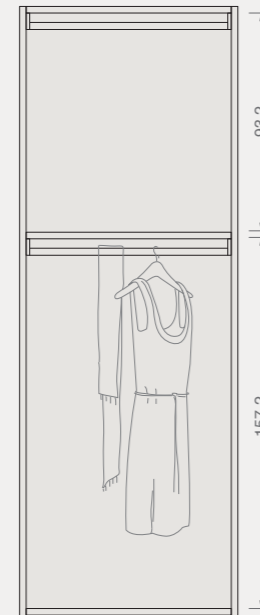

1 ripiano
2 tubi appendiabiti
1 shelf
2 coat-hangers

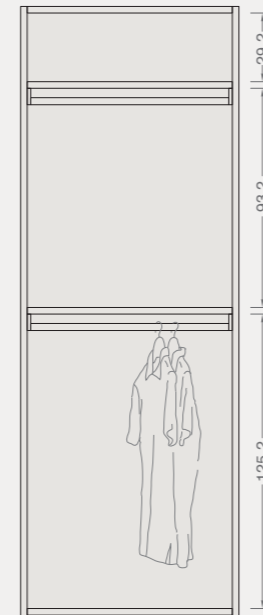

2 ripiani
2 tubi appendiabiti
2 shelves
2 coat-hangers

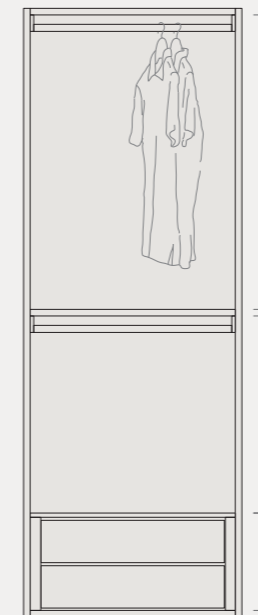

1 ripiano
2 tubi appendiabiti
1 cassettiera interna con 2 cassetti
1 shelf
2 coat-hangers
1 inner drawer with 2 drawers

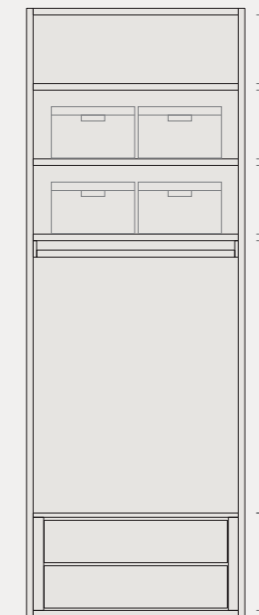

3 ripiani
1 tubo appendiabiti
1 cassettiera interna con 2 cassetti
3 shelves
1 coat-hanger
1 inner drawer with 2 drawers

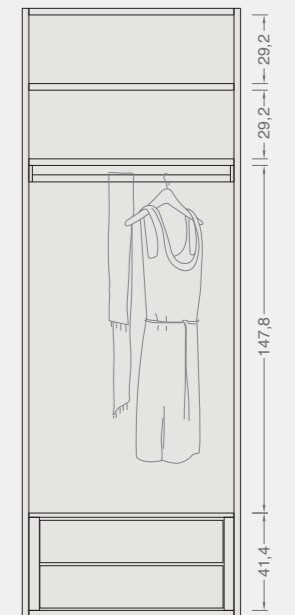

2 ripiani
1 tubo appendiabiti
1 cassettiera interna con 2 cassetti
2 shelves
1 coat-hanger
1 inner drawer with 2 drawers

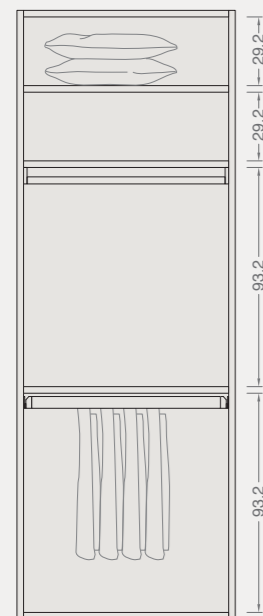

3 ripiani
1 tubo appendiabiti
1 porta pantaloni estraibile
3 shelves
1 coat-hanger
1 removable trousers rack

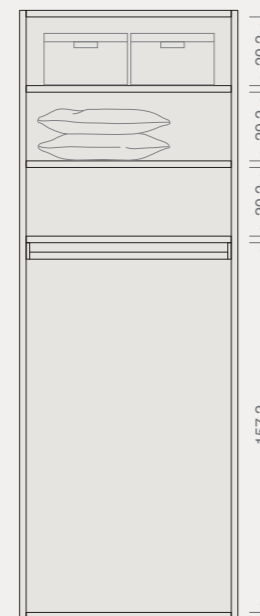

3 ripiani
1 tubo appendiabiti
3 shelves
1 coat-hanger

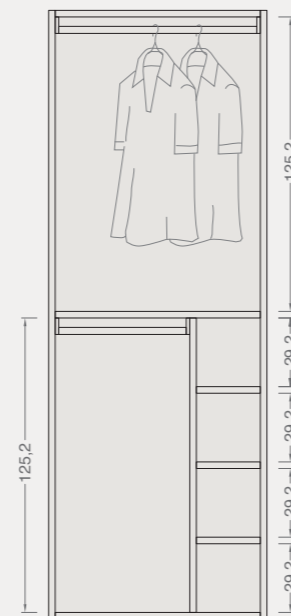

1 ripiano largo
3 ripiani stretti
2 tubi appendiabiti
1 tramezza interna
1 large shelf
3 close shelves
2 coat-hangers
1 inner side

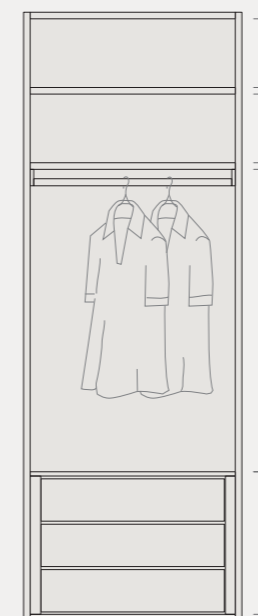

2 ripiani
1 tubo appendiabiti
1 cassettiera interna con 3 cassetti
2 shelves
1 coat-hanger
1 inner drawer with 3 drawers

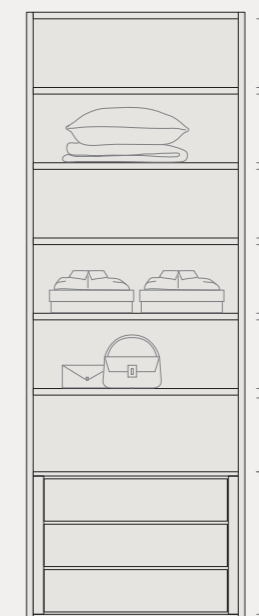

5 ripiani
1 cassettiera interna con 3 cassetti
5 shelves
1 inner drawer with 3 drawers

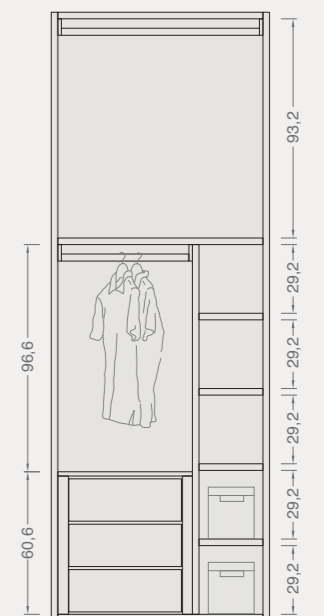

1 ripiano largo
4 ripiani stretti
2 tubi appendiabiti
1 cassettiera interna con 3 cassetti
1 tramezza interna
1 large shelf
4 close shelves
2 coat-hangers
1 inner drawer with 3 drawers
1 inner side

ESEMPI DI ORGANIZZAZIONE INTERNA DEGLI SPAZI (proposte su colonna H 259,2 cm)

Examples of internal organization of spaces (proposals on H 259,2 cm column)

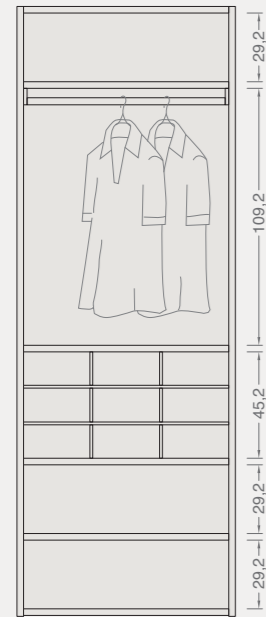

4 ripiani
1 tubo appendiabiti
1 crociera interna
4 shelves
1 coat-hanger
1 inner cruiser

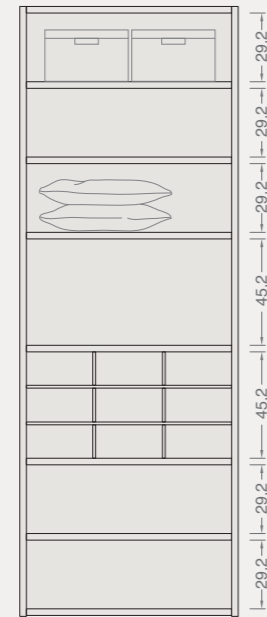

6 ripiani
1 crociera interna
6 shelves
1 inner cruiser

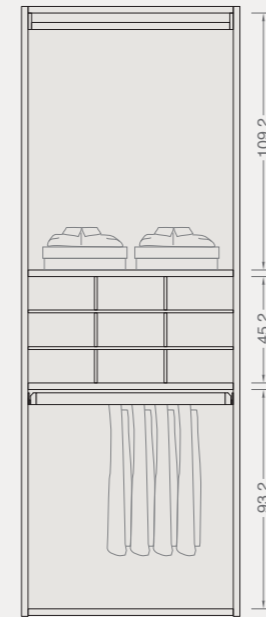

2 ripiani
1 tubo appendiabiti
1 porta pantaloni estraibile
1 crociera interna
2 shelves
1 coat-hanger
1 removable trousers rack
1 inner cruiser

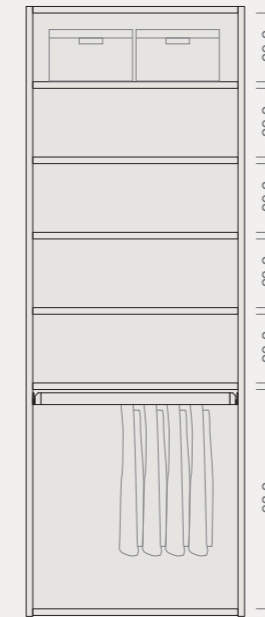

5 ripiani
1 porta pantaloni estraibile
5 shelves
1 removable trousers rack

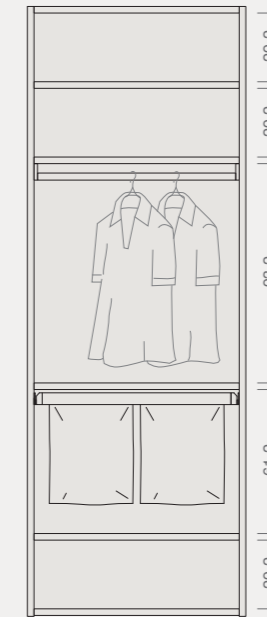

4 ripiani
1 tubo appendiabiti
1 coppia cesti estraibili
4 shelves
1 coat-hanger
1 couple of removable baskets

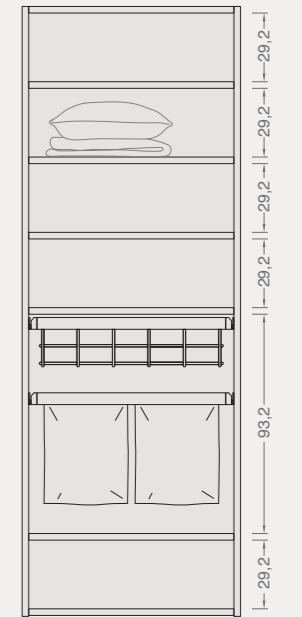

5 ripiani
1 cassetto in filo estraibile
1 coppia cesti estraibili
5 shelves
1 removable drawer
1 couple of removable baskets

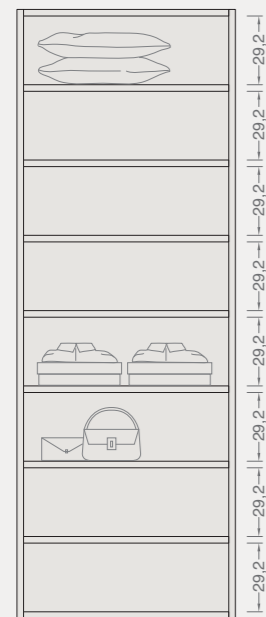

7 ripiani
7 shelves

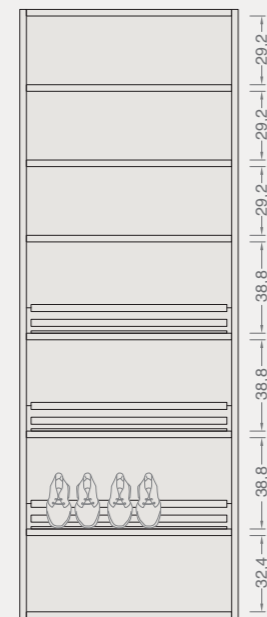

3 ripiani
3 ripiani inclinati porta scarpe
3 shelves
3 inclined shoes rack shelves

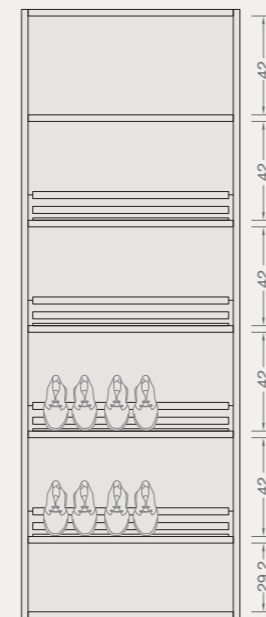

1 ripiano
4 ripiani inclinati porta scarpe
1 shelf
4 inclined shoes rack shelves



4 ripiani
4 cassetti in filo estraibili
4 shelves
4 removable drawers

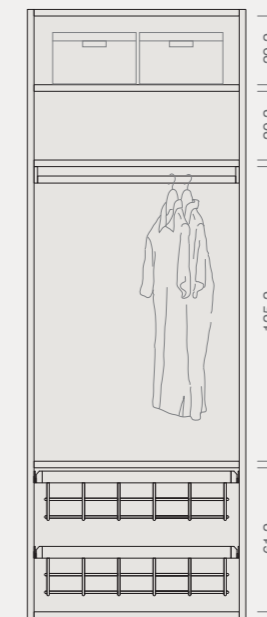

3 ripiani
1 tubo appendiabiti
2 cassetti in filo estraibili
3 shelves
1 coat-hanger
2 removable drawers

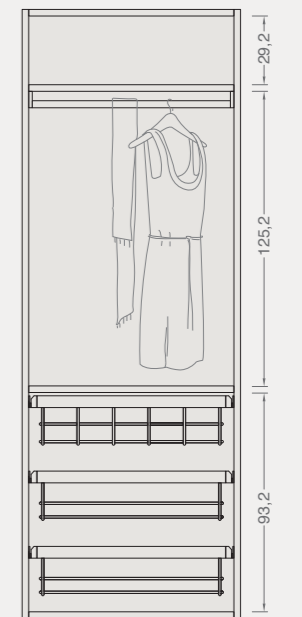

2 ripiani
1 tubo appendiabiti
1 cassetto in filo estraibile
2 porta scarpe estraibili
2 shelves
1 coat-hanger
1 removable drawer
2 removable shoes racks

FINITURE

Finishes

Nobilitati per struttura / frontali Melamine facing for frames/fronts



Bianco

Madreperla

Olmo Canapa

Noce Sider

Noce Lloyd

Noce Cotto

Nobilitati per frontali Melamine facing for fronts



Rovere Nodato

Noce Canaletto

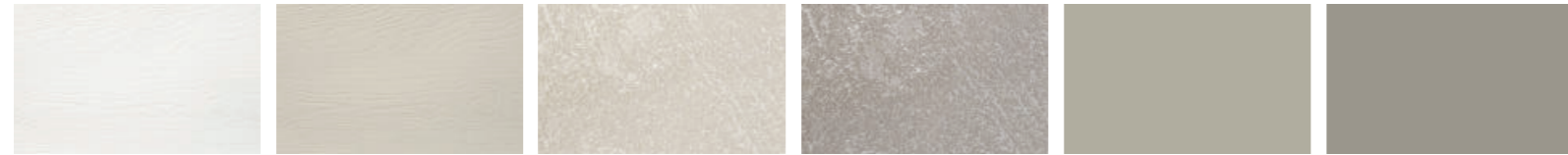

Gessato Bianco

Gessato Madreperla

Beton Madreperla

Beton Sabbia

Salis

Sabbia



Platino

Grafite

Nobilitati per schiene sp. 06 cm e cassettiere interne Melamine for th. 06 cm backs and inner drawers



Bianco Millerighe

Canvas

Tipologia di laccatura per strutture e frontali Lacquer types for frames and fronts



Laccato Opaco

Laccato Opaco Gessato
(solo frontali - only fronts)

Laccato Lucido

Colori laccati Lacquered colours



Neve

Bianco

Crema

Platino

Madreperla

Salis



Sabbia

Fango

Mango

Ocra

Limone

Cognac



Magnolia

Ruggine

Corallo

Prugna

Menta

Giada



Verde Laguna

Verde Militare

Verde Muschio

Luce

Blu

Blu Avio



Blu Notte

Grigio Londra

Grigio Cenere

Grafite

Antracite

Nero

Laccati opachi a riferimento Matt lacquer per client's reference



Laccato opaco RAL - RAL matt lacquer
Laccato campione cliente - Client's lacquered sample

FINITURE

Finishes

Laccati Metal Metal lacquer



Perla Metallizzato

Gold Metallizzato

Titanio Metallizzato

Alluminio Metallizzato

Piombo

Metal Grey

Iron



Bronzo

Ottone

Corten

Touch



Touch Bianco

Touch Madreperla

Touch Sabbia

Vetri Glass



Trasparente

Grigio Europa

Specchio Mirror

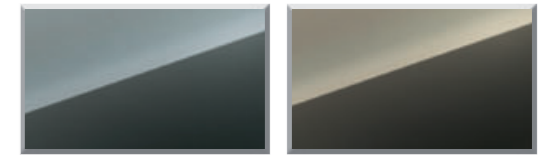

Argentato

Brunito

Vetri laccati Lacquered glass



Bianco

Platino

Madreperla

Salis

Sabbia

Fango



Grigio Londra

Grigio Cenere

Grafite

Antracite

SERIGRAFIE MOVIE

Movie silk-screen printing

VINTAGE

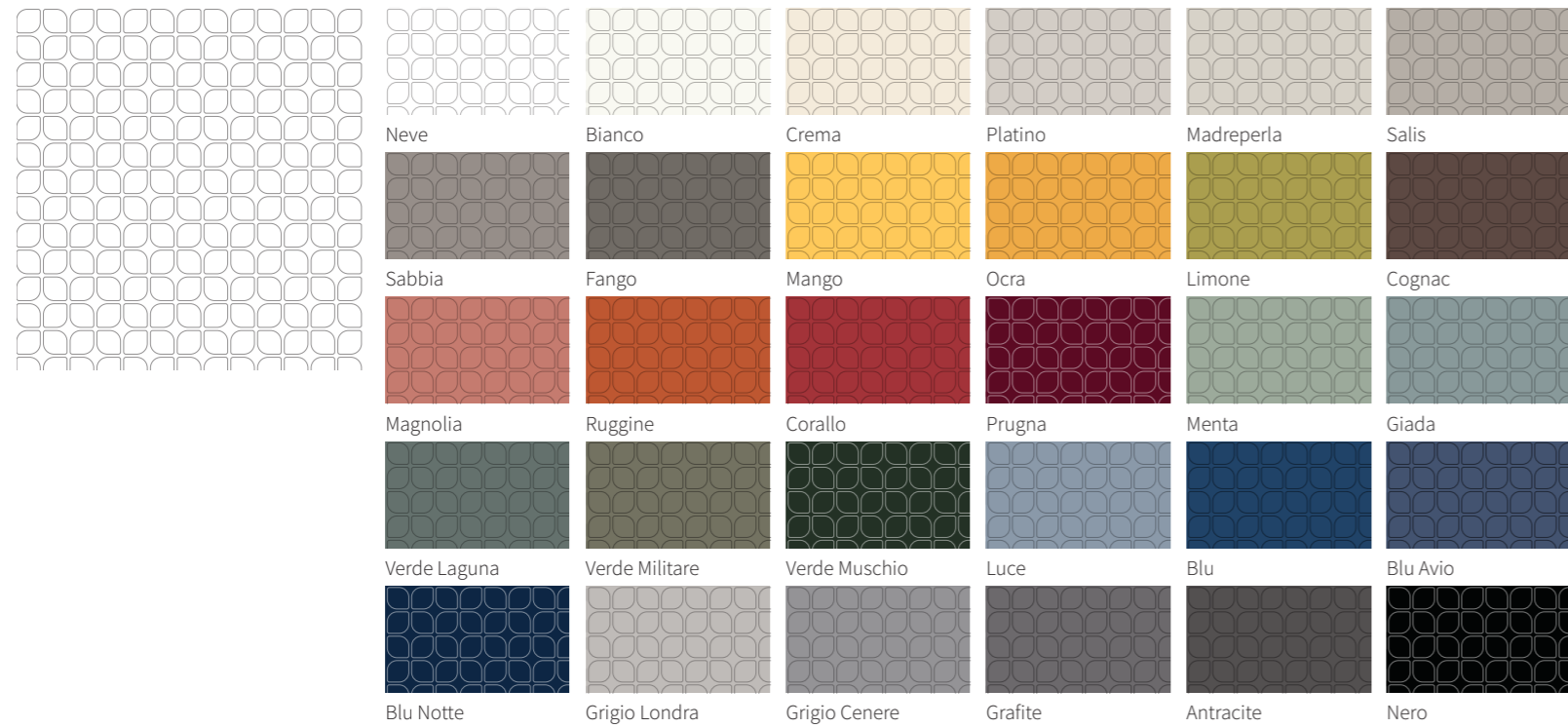

ROMBO



N.B. : È inoltre possibile realizzare serigrafie di qualsiasi immagine desiderata, facendola pervenire alla Spagnol Mobili sotto forma di file ad alta definizione
 N.B. Silk-screen printing of any image desired is also possible by sending Spagnol Mobilia high definition file

ILLUSION

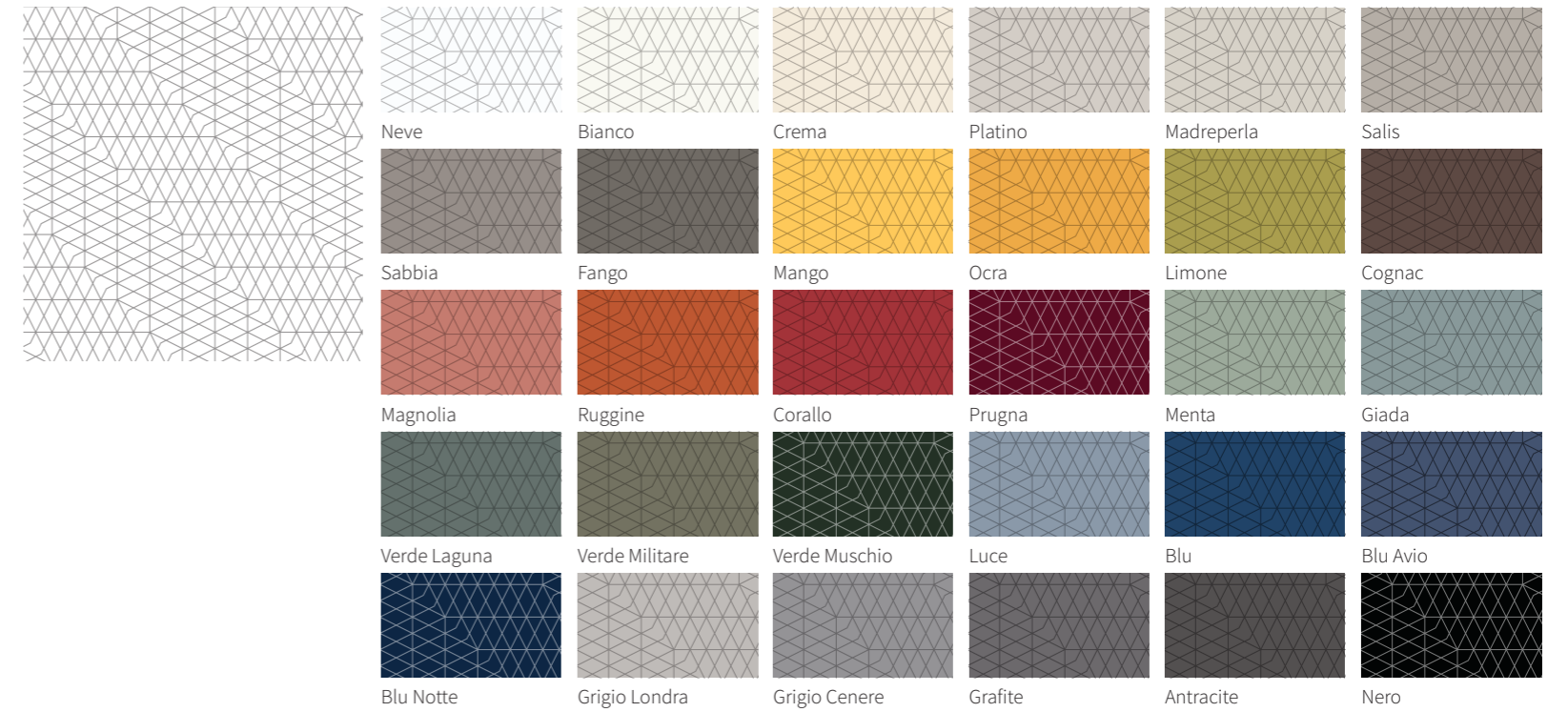

OPTICAL



N.B. : Per disponibilità finitura nei vari articoli consultare il listino prezzi / Le finiture ed i colori sono indicativi e possono subire variazioni dovute alla tecnica di stampa
 N.B. Refer to the price list for the possible finishes of the various items / The finishes and colours are for illustration only and may vary due to the printing technique



MOBIL S.r.l.

Via Vidor, 1
31010 Mosnigo di Moriago
(Treviso) ITALY

Tel. +39 0438 89 11
Fax +39 0438 89 00 82
E-mail mobili@spagnol.it
Web www.spagnol.it
Web www.spagnolmobili.it

EXPORT DEPARTMENT

Tel. +39 0423 98 87
Fax +39 0423 98 88 36
E-mail export@spagnol.it



© MOBIL S.r.l.



L'azienda si riserva di apportare senza preavviso modifiche tecnico-costruttive, nei materiali e nelle finiture, tali da non pregiudicare le caratteristiche essenziali del prodotto descritto o illustrato.

I colori ed i materiali rappresentati nelle immagini hanno valore indicativo in quanto soggetti alle tolleranze dei processi di stampa.

Company reserves the right to make unannounced technical and structural changes, in materials and finishes, such as not undermine the essential characteristics of the described and illustrated product.

Colors and materials shown in the pictures are indicative as they are depending on the tolerances of the printing process.



SPAGNOLmobili



Mobil S.r.l. - Spagnol Mobili

Via Vidor, 1 - 31010 Mosnigo di Moriago (TV) - ITALY

Tel. +39.0438.89.11 - Fax +39.0438.89.00.82

www.spagnol.it - www.spagnolmobili.it - mobili@spagnol.it